

Distributed by
Raymarine

Any reference to Raytheon or RTN in this manual should be interpreted as Raymarine. The names Raytheon and RTN are owned by the Raytheon Company.

Autohelm™

ST4000

**TILLER
AUTOPILOT**
Operation and
Installation

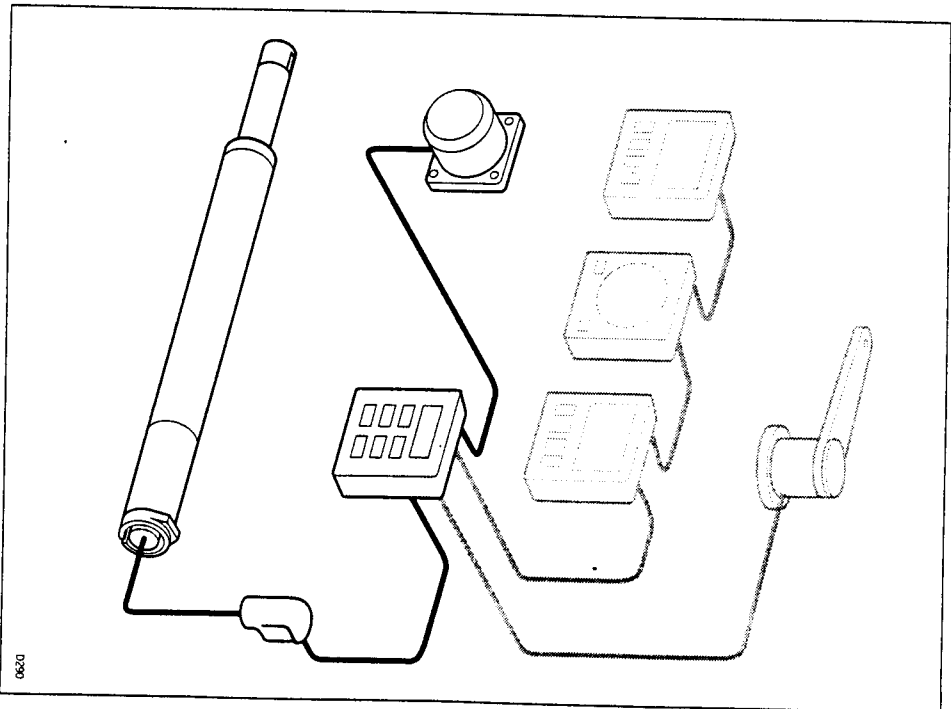

ST4000 Tiller Drive Autopilot

Contents

Specifications
Introduction
Safety

Basic Operation

Chapter 1: Operation
1.1 Basic principles
1.2 Operator controls
Standby
Auto
Course changes (-1, +1, -10, +10)
Dodge
'Track Control'
Windvane Mode (WindTrim)
Automatic Deadband Control (Auto seastate)
Automatic Tack (Autotack)
Illumination
Off Course Alarm
1.3 Operating hints

Advanced Operation

Chapter 2: Using 'Track Control' and 'WindTrim'
Chapter 3: Adjusting autopilot performance
Chapter 4: Autopilot re-calibration

Installation

Chapter 5: Installation
Chapter 6: Interfacing to GPS, Decca, Loran, Wind
Chapter 7: Functional Test and Initial Sea Trial
Chapter 8: Accessories
Chapter 9: Maintenance
Chapter 10: Fault Finding

Specifications

- Power Supply
 - 10 to 15V d.c.
- Current consumption
 - Standby: 65mA (120mA with lighting)
 - Auto: between 0.7A and 2.5A depending on boat trim, helm load and sailing conditions
- Operating temperature
 - 0°C to +70°C
- 6 button digital keypad
- LCD display of heading, locked course and navigational information
- User calibration for optimum performance
- WindTrim control in windvane mode
- Seatalk compatible
- Automatic compass deviation correction
- Northerly/Southerly heading compensation
- Automatic heading deadband
- Automatic tack
- Built-in radio navigation interface
- Waypoint advance feature

Introduction

The ST4000 is an integrated autopilot for tiller steered yachts. The basic system comprises of 3 units:

- Permanently mounted control head
- Linear drive actuator
- Remote fluxgate compass for precise heading information

The control head is Seatalk compatible and therefore can share all data transmitted from other Autohelm SeaTalk instruments:

- Wind information from a wind instrument can be used for windvane steering without the need to install a separate vane
- Track information from either Navdata or Navcenter instruments provides waypoint control from the autopilot
- Boat speed from the Speed instrument for optimum Track keeping performance
- Seatalk compatibility also allows additional fixed and handheld autopilot control units to be easily connected at secondary steering and control positions

The Control head also includes a built in Navigation interface for use with any position transducer (GPS, Decca, Loran) transmitting NMEA 0183 data.

The linear actuator is mounted between the tiller and a single attachment point on the yacht's structure.

The ST4000 can be calibrated to suit each installation giving maximum performance with many types of boats.

Important Note: The ST4000 is recommended for tiller steered vessels up to 15,000 lb (7000kg) displacement. Above this limit for heavy duty applications, such as single handed racing or long distance ocean sailing, one of the more powerful Autohelm autopilots (ST4000GP, ST6000, ST7000) is advised.

Safety

Passage making under autopilot can greatly increase the pleasure of the voyage and ensure the crew can relax. However, this can lead to a dangerous lack of attention to basic seamanship. The following rules should always be observed:

- Maintain a permanent watch and check regularly all round for other vessels and obstacles to navigations. No matter how clear the sea may appear a dangerous situation can develop rapidly
- Maintain an accurate record of the vessels position either by use of a radio navigation receiver or visual bearings
- Maintain a continuous plot of position on a current chart. Ensure the locked autopilot heading steers you clear of all obstacles. Make proper allowance for Tidal Set – the autopilot cannot!
- Even when your autopilot is locked to the desired Track using a radio navigation receiver maintain a log and a regular positional plot. Radio navigation signals can produce significant errors under some circumstances and the autopilot cannot detect this situation
- **Ensure that all members of crew are familiar with the procedures required to disengage the autopilot**
- When searoom is restricted a crew member must be close to the control head at all times if under autopilot control

Your Autohelm ST4000 will add a new dimension to your boating enjoyment. However, it is the responsibility of the skipper to ensure the safety of the vessel at all times by careful observance of these basic rules.

Basic Operation

Contents

Chapter 1: Operation	7
1.1 Basic principles	7
1.2 Operator controls	8
Standby	8
Auto	8
Course changes (-1, +1, -10, +10)	9
Dodge	10
'Track Control'	11
Windvane Mode (WindTrim)	11
Automatic Deadband Control (Auto seastate)	12
Automatic Tack (Autotack)	13
Illumination	14
Off Course Alarm	14
1.3 Operating hints	15

Chapter 1: Operation

1.1 Basic principles

When switched on, the ST4000 will be in 'Standby' mode. To select automatic steering simply steady the vessel on the required heading, place the actuator over the tiller pin and push **Auto**. At any time to return manual steering push **Standby** and lift the pilot off the tiller pin.

Autopilot control has been simplified to a set of pushbutton operations of which are confirmed with a 'beep' tone. In addition to the main single functions there are several dual key press functions. Course changes can be made at any time using the **-1**, **+1**, **-10**, and **+10** degree keys.

Passage making under automatic pilot is a very pleasant experience which can lead to the temptation of relaxing permanent watch. This must always be avoided no matter how clear the sea may appear to be.

Remember, a large ship can travel two miles in five minutes – it the time it takes to make a cup of coffee.

The next few pages list all of the pushbutton operations needed for full autopilot control.

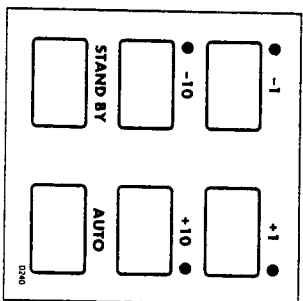

1.2 Operator controls

Standby

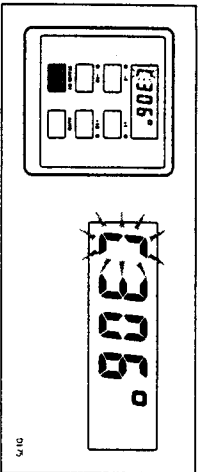

- Push to disengage the autopilot for hand steering

The previous auto heading is memorised and can be recalled using the **Auto** key (see 'Auto').

In 'Standby' the display shows the vessels current compass heading.

Auto

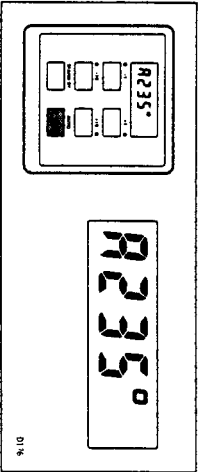

- Push to engage automatic steering and maintain current heading

In 'Auto' the display shows the locked autopilot heading.

If for any reason the vessel is steered away from the selected locked heading (e.g. Dodge manoeuvre or selecting 'Standby') then:

- Push and hold down **Auto** for 1 second

The previous locked heading will be flashed for 10 seconds. To select this heading, and resume the original course, press the **Auto** key once within 10 seconds.

Also see 'Dodge' – page 10.

Course changes (-1, +1, -10, +10)

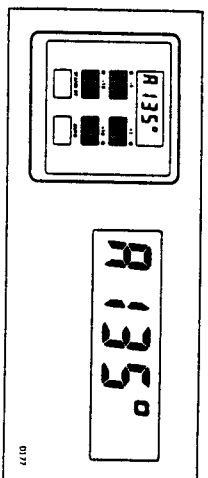

- Push to alter course to Port (-) and Starboard (+) in increments of 1 and 10°

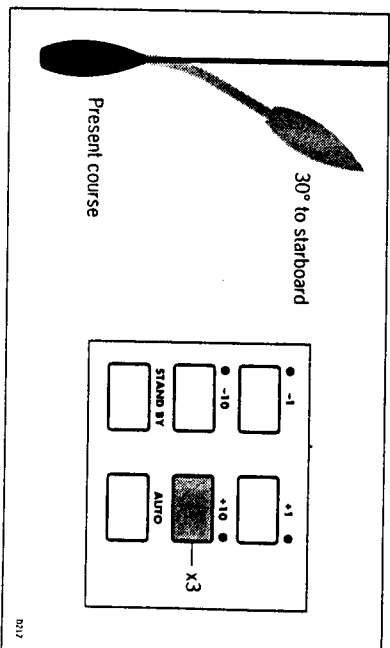

30° course change to Starboard

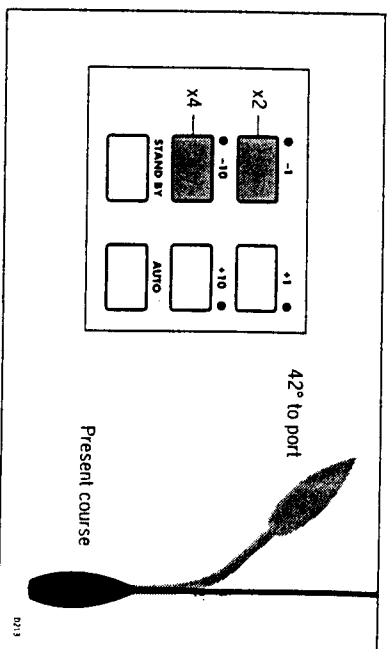

42° course change to Port

Dodge

In order to avoid an obstacle under autopilot control select a course change in the appropriate direction (Say starboard 30° = 3 x +10°).

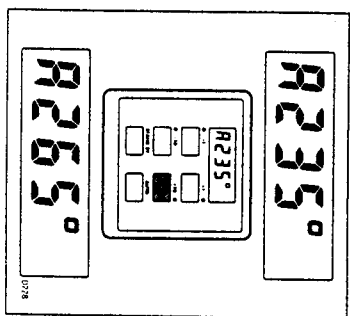
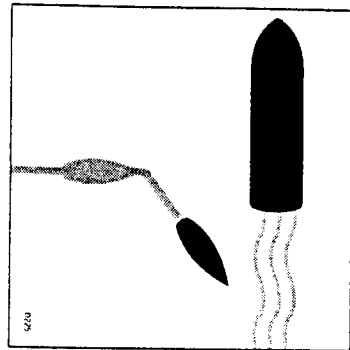

When safely clear of the obstacle press and hold down **Auto** for 1 second.

The previous locked heading will now be flashed on the screen. To return to the old course press **Auto** within 10 seconds.

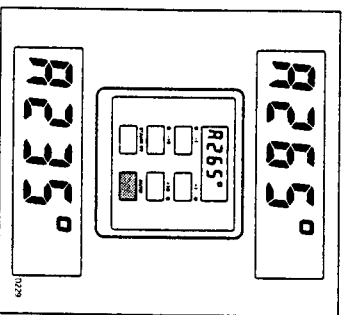
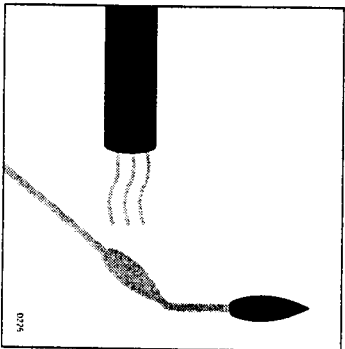

Alternatively the previous course change can be reversed via the key pad example: 3 x -10°.

'Track Control'

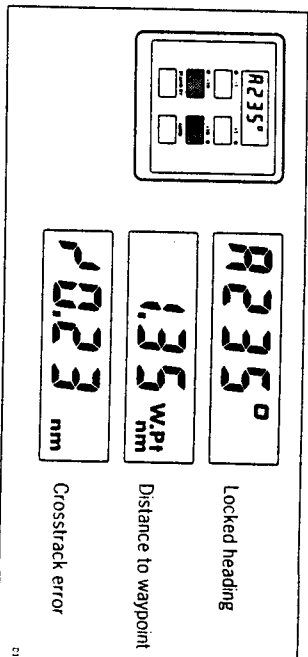

- Push **+10** and **-10** degree keys together to select 'Track Control' from Auto. Push again to return to automatic steering.
- Once in 'Track Control' the autopilot will follow a predetermined track set up on a GPS/Decca/Loran navigation receiver, see 'Advanced Operatic for more details.

Windvane Mode (WindTrim)

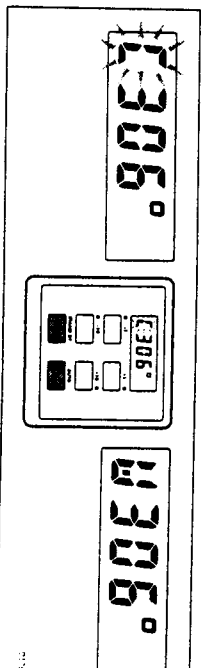

- Push **Auto** and **Standby** together to select 'WindTrim' and maintain the current apparent wind angle
- If for any reason the vessel is steered away from the selected Apparent wind angle (i.e. Dodge manoeuvre or selecting Standby) then:
- Push and hold down for 1 second both the **Auto** and **Standby** keys together to return to the previous Apparent wind angle

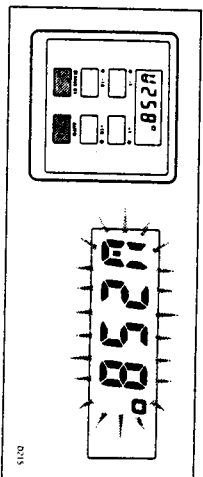

Whilst in Windvane mode the control head will beep once every 30 seconds.

Automatic Deadband Control (Auto seastate)

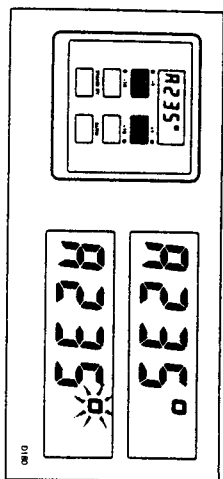

- Press the **+1** and **-1** degree course change keys together to toggle between auto deadband and fixed minimum deadband. The degree sign will flash when the fixed minimum dead band is selected. This can only be done with the Autopilot in 'Auto' mode.

'Automatic deadband' (Auto seastate) will cause the pilot to gradually neglect repetitive movements of the vessel and only respond to true variations in course. This provides the best compromise between power consumption and course keeping accuracy by neglecting unnecessary rudder movements.

Minimum deadband will always provide the tightest course keeping possible but at the expense of increased power consumption and drive unit activity.

Automatic Tack (Autotack)

The ST4000 has a built in automatic tack facility which will turn the vessel through 100° in the required direction. This feature is available in both compass and vane modes.

- Press the **+1** and **+10** degree keys together to Tack through 100° to starboard

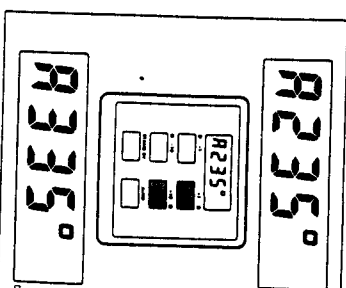
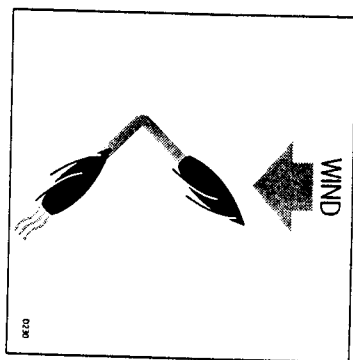

Or:

- Press the **-1** and **-10** degree keys together to Tack through 100° to port

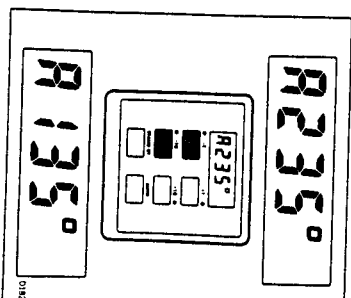
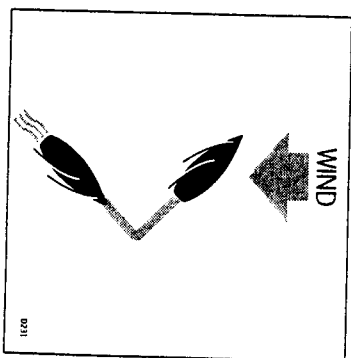

Illumination

Illumination for the control head display can be switched on for night time viewing. This can only be done with the autopilot in 'Standby' mode

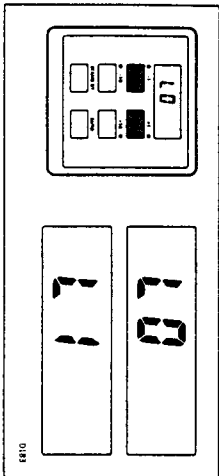

- Press the **+1** and **-1** keys together to toggle illumination on and off
- Also if other SeaTalk instruments or autopilot control units are connected to the SeaTalk bus the illumination on the ST4000 can be switched on or off from these units.

Off Course Alarm

The off course alarm will sound if the locked autopilot heading and the vessels current heading differ, for greater than 20 seconds, by more than the value set in calibration level 6.

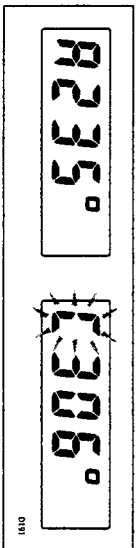

To cancel the off course alarm push **Standby** to return to hand steering. If the off course alarm sounds it is usually an indication that the vessel is carrying too much sail, or that the sails are badly balanced. In this case a significant improvement in course keeping can usually be obtained by improving sail balance.

1.3 Operating hints

It is very important to understand the effect of sudden trim changes on steering performance. When a sudden trim change occurs, due for example to weather helm or sail imbalance, there will be a delay before automatic trim applies rudder to restore the locked heading. This correction can take up to one minute. Large course changes which change the apparent wind direction can produce large trim changes. In these cases the autopilot will not immediately assume the new automatic heading, and will only settle onto course when the automatic Trim has been fully established.

To minimise the time delay the following procedure may be adopted for large course changes.

- Note required new heading
- Select **Standby** and steer manually
- Bring vessel onto new heading
- Select **Auto** and let vessel settle onto course
- Bring to final course with 1° increments

It is sound seamanship to make major course changes only whilst steering manually. In this way any obstructions or other vessels may be cleared properly and due account taken of the changed wind and sea conditions on the new heading prior to engaging the autopilot.

In gusting conditions the course may tend to wander slightly, particularly the case of a sailing yacht with badly balanced sails. In the latter case, a significant improvement in course keeping can always be obtained by improving sail balance. Bear in mind the following important points:

- Do not allow the yacht to heel over excessively
- Ease the mainsheet traveller to leeward to reduce heeling and weather helm
- If necessary reef the mainsail a little early

It is also advisable whenever possible to avoid sailing with the wind dead astern in very strong winds and large seas.

Ideally, the wind should be brought at least 30° away from a dead run and in severe conditions it may be advisable to remove the mainsail altogether and sail under headsail only. Provided these simple precautions are taken the autopilot will be able to maintain competent control in gale force conditions.



Advanced Operation

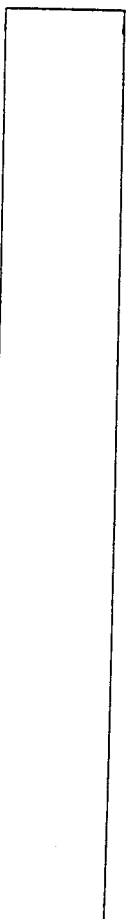

Contents

Chapter 2: Using 'Track Control' and 'WindTrim'	20
2.1 Operation in 'Track Control'	20
Operating hints	20
Cross track error	21
Tidal Stream Compensation	22
Waypoint Advance	22
Limitations	23
Low Speed Operation	23
Dodges	24
Safety	24
Warning messages	25
NMEA data not received	25
NMEA data error	25
Large cross track error	25
Waypoint advance	25
2.2 Operation in 'WindTrim' mode	26
Operating hints	26
Wind shift alarm	27
Chapter 3: Adjusting autopilot performance	28
3.1 Setting up Rudder Gain	28
3.2 Setting up Automatic Trim	30
Chapter 4: Autopilot re-calibration	31
4.1 Entering calibration mode	31
4.2 Exiting calibration mode	32
4.3 Suggested initial calibration settings	32
4.4 Calibrating the autopilot to suit your boat	34
Calibration Level 1 (Rudder Gain)	34
Calibration Level 2 (Rudder Offset)	34
Calibration Level 3	34
Calibration Level 4 (Turn Rate Limit)	35
Calibration Level 5 (Cruise Speed)	35
Calibration Level 6 (Off course alarm angle)	35
Calibration Level 7 (Trim Level)	36
Calibration Level 8 (Steering system type)	37
Calibration Level 9 (Magnetic variation)	37
Calibration Level 10 (N'Iy/S'Iy heading error correction)	37
Calibration Level 11 (Current Vessel Latitude)	38
Calibration Level 12 (Not available with the ST4000)	39
Calibration Level 13 (Rudder Damping)	39
4.5 Disabled calibration access	41

Advanced operation

The ST4000 has been setup at the factory to provide stable performance for most types of boat. Depending on personal choice and type of boat many of the functions and features available in the ST4000 can be fine tuned. This is normally required if:

- The pilot does not maintain a selected heading
- A rudder reference transducer is fitted
- The boat appears to be unstable on Northerly headings (Southernly headings in the southern hemisphere)
- You wish to display True compass headings
- You operate in 'Track Control' mode
- You wish to change the Off Course alarm angle

The ST4000 is also capable of being supervised from a Navigation system such as a GPS, Decca or Loran receiver – automatically compensating for tidal streams and leeway. Courses relative to the apparent wind direction can also be maintained if the ST4000 is connected to a wind transducer.

'Advanced Operation' offers a complete guide to ST4000 calibration and comprehensively covers operation in both 'Track Control' and 'WindTrim' supervisory modes. It also shows how the system can be expanded to include other SeaTalk products.

Chapter 2: Using 'Track Control' and 'WindTrim'

2.1 Operation in 'Track Control'

'Track Control' allows the ST4000 to maintain track between two waypoints entered on a GPS, Decca, or Loran based Navigation system.

Operating hints

The Control head can receive cross track error data from any Navigation system transmitting data to the NMEA 0180 or 0183 format. The ST4000 will then compute course changes which will keep your boat on a pre-determined track, automatically compensating for tidal streams and leeway.

When initiating 'Track Control' the track can be acquired in one of two ways:

- Automatic acquisition (NMEA 0183 Cross Track Error and Bearing to Waypoint data required from the receiver)
- Manual acquisition (NMEA 0180 or 0183 Cross Track Error data required only)

Manual acquisition is achieved by steering the vessel to within 0.1nm of track and then bringing the heading to within 5° of the bearing to the next waypoint. The pilot is then switched over to 'Track Control' by firstly entering 'Auto' and then pressing the **+10** and **-10** degree keys together to initiate 'Track Control'. The Display will alternate between Cross track error and the locked pilot heading.

Automatic acquisition can only be achieved if the pilot is receiving NMEA 0183 Cross track error and bearing to waypoint information via the SeaTalk bus. It is initiated as follows:

- Bring the vessel to within 0.1nm of Track
- Press **Auto**
- Press **+10** and **-10** degree keys together to enter 'Track Control'

An alarm will sound and the display will show:

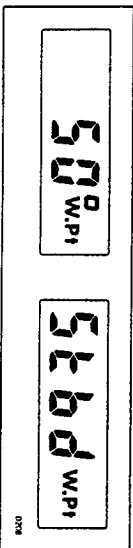

The information on the display alternates between the direction in which the boat will turn to take up the track and the new bearing to waypoint.

Check that it is safe to turn onto the new course.

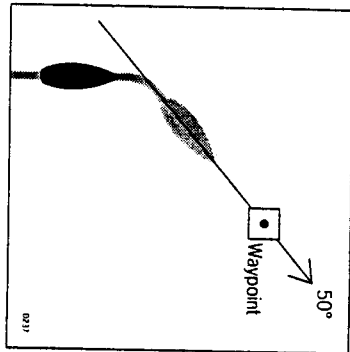

- Press the **+10** and **-10** degree keys together

The boat will now turn on to the new course and the alarm will cancel. The following navigation information will now be continuously cycled on display:

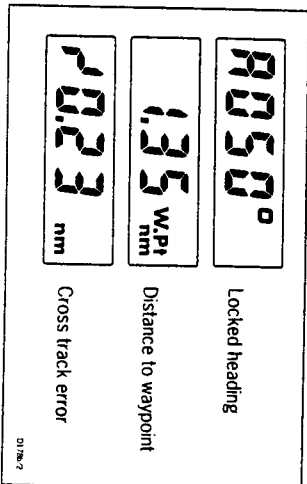

Cross track error

Cross track error is the vessel distance from a planned route. This is displayed in nautical miles and is read directly from your position transducer (see above).

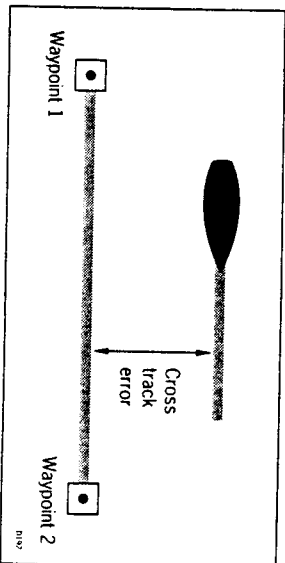

Tidal Stream Compensation

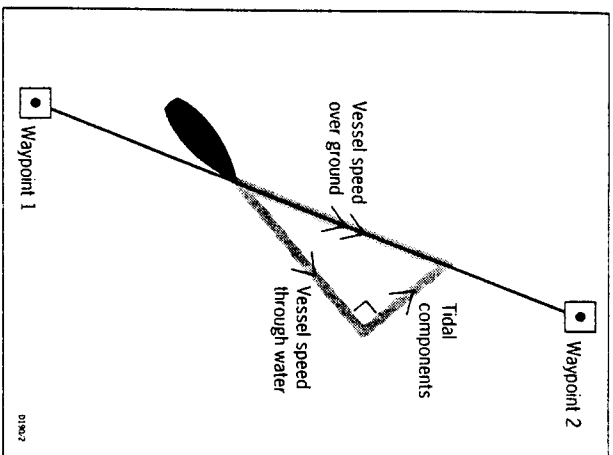

Under most conditions 'Track Control' will hold the selected track to within $\pm 0.05\text{nm}$ (300ft) or better.

The autopilot takes account of vessel speed when computing course changes to ensure optimum performance over a wide range of vessel speeds. If an Autohelm ST150 Speed or Tridata instrument is connected to the SeaTalk bus the control head will use measured vessel speed, otherwise the cruise speed entered during calibration level 5 will be used.

Waypoint Advance

If your navigation receiver transmits valid 'Waypoint Number' and 'Bearing to Waypoint' NMEA headers it is possible to advance from one waypoint to the next by simply pressing the **-10** and **+10** degree keys together.

As the vessel passes the target waypoint the navigation receiver should select, manually or automatically, the next target waypoint. The ST4000 will detect the new target waypoint number and display the new bearing to waypoint and also the direction it will turn to acquire it. This will be accompanied by an alarm to indicate waypoint arrival (see page 25).

Limitations

Note: While the waypoint advance alarm is sounding, 'Track Control' is suspended and the ST4000 will maintain the current boat heading. A check should be made to verify it is safe to turn onto the new track and then the **+10** and **-10** degree keys pressed together. This will cancel waypoint arrival alarm and steer the boat towards the next waypoint. Unless the 'Waypoint Advance' is accepted in the above way the alarm continue to sound and the current course be maintained.

Although there is no need to fully understand the details of the track keeping algorithm, it is very important to understand its limitations so to obtain the best performance from 'Track Control'. The most significant these limitations is imposed if NMEA 0180 cross track error data is transmitted by the radio navigation receiver. This data is restricted to $\pm 0.30\text{nm}$, which means that even if the vessel were 5 miles to starboard of track, the transmitted data would still be 0.30nm.

Attempts to engage 'Track Control' beyond the 0.30nm limit will lead to excessive overshoots and can result in the vessel circling. For this reason the alarm code is displayed (see page 25) whenever the cross track error exceeds 0.30nm. The requirement to remain within 0.30nm of track also limits the maximum allowable angular error between the track course and the vessel's heading. If the angular error is too great, the 'Track Control' will be unable to cancel it within the 0.30nm limit leading to the problem outlined above.

The NMEA 0183 format transmits cross track error data up to 99.99nr and enables the 'Track Control' to operate with larger cross track errors. However, the alarm code will still be displayed over 0.30nm in case there are navigational hazards close to the intended track.

Low Speed Operation

Operation of the manual acquisition of 'Track Control' at low speeds requires additional care as the effect of tidal streams is far more significant than at higher speeds. In general terms, providing the tidal flow is less than 35% of the vessel speed no noticeable difference will occur in the performance of 'Track Control'. However, extra care should be taken to ensure that the vessel is as close as possible to track, and that the direction made good over the ground is as close as possible to the direction of the next waypoint, before engaging 'Track Control'. Under these circumstances positive positional checks at regular intervals are vital especially if navigational hazards are close.

Dodges

Full control remains available from the control head when the autopilot is in 'Track Control'. Dodges are accomplished by simply selecting the desired course change on the Autohelm keypad. Once the hazard has been avoided the course change selected for the dodge manoeuvre should be cancelled by selecting an equal course change in the opposite direction. Provided the vessel remains within 0.1nm of track there is no need to steer back towards the track.

Safety

Passage making in 'Track Control' removes the chores of compensation for wind and tidal drift and will aid precise navigation. It is most important however to maintain an accurate log with regular plots and to verify the computed position read from the radio navigation receiver with a dead reckoned position from recording the average course steered and the distance logged. In open water such plots should be at least hourly and more frequent in confined waters or when potential hazards are near.

Local variations in radio signal quality and changes in the tidal stream will produce deviations from the desired track. When setting up waypoints, remember that deviations will occur, and thoroughly check along each track and to 0.5nm each side to ensure that there are no hazards within the zone. Always confirm the position given by the position transducer using an easily identifiable fixed object at the start of a passage to check and enable compensation to be made for fixed positional errors.

The use of 'Track Control' will enable accurate track keeping even in complex navigational situations. It cannot remove the responsibility of the skipper to ensure the safety of his vessel at all times by careful navigation and frequent position checks.

Warning messages

NMEA data not received



The 'no data' display will be shown if 'Track Control' is engaged when the autopilot is not receiving either NMEA 0180 or 0183 data.

NMEA data error



The 'data error' display will be shown if 'Track Control' is engaged while the Position Transducer (GPS, Loran, Decca) is receiving a low strength signal.

This will clear as soon as the signal strength improves.

Large cross track error



The 'large cross track error' alarm sounds if the cross track error received by the pilot exceeds 0.3nm.

Waypoint advance

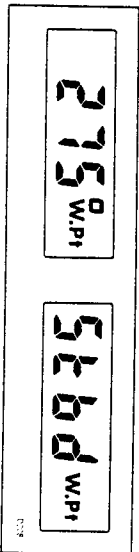

The waypoint advance alarm sounds whenever the Radio Navigation Receiver (GPS, Loran, Decca) changes the target waypoint number. When this occurs the pilot will continue on its current heading but flash the bearing to the next waypoint on the display. This will alternate with the direction in which the boat will turn to take up that bearing. You should check to ensure that such a manoeuvre would be safe and when you are ready to make the turn, momentarily press the +10 and -10 degree keys together. The pilot will then turn onto the new bearing and track towards the next waypoint.

Note: The waypoint advance will only operate on pilots receiving NMEA 0183 bearing to waypoint information.

2.2 Operation in 'WindTrim' mode

WindTrim' mode allows the ST4000 to maintain course relative to an apparent wind angle. It uses 'WindTrim' to eliminate the effects of turbulence and short term wind variations and provide smooth precise performance under windvane with minimum power consumption. 'WindTrim' uses the fluxgate compass as the primary heading reference, and as changes in the apparent wind angle occur the locked compass heading is adjusted to maintain the original apparent wind angle. To use 'WindTrim' the ST4000 must receive wind information from one of the following sources:

- SeaTalk Wind instrument – connected to the ST4000 via the SeaTalk bus
- NMEA wind information connected to the rear of the Control head
- Autohelm windvane (cat no Z087) connected via the SeaTalk interface box (cat no Z137)
- ST7000 or ST6000 autopilot control unit (cat no Z082 and Z124)

Operating hints

WindTrim' filters the windvane output, providing optimum response for offshore conditions where genuine shifts in wind direction occur gradually. In gusty and unsteady inshore conditions it is best to sail a few degrees further off the wind so that changes in apparent wind direction can be tolerated.

It is also important to ensure that the amount of standing helm is minimised by careful sail trim and positioning of the mainsheet traveller.

It is recommended that the headsail and mainsail are reefed a little early rather than too late.

Wind shift alarm

If changes in apparent wind angle adjust the original locked compass heading by more than 15° the wind change alarm will sound

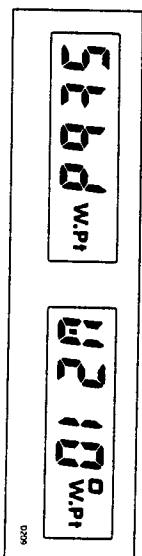

The display will then alternate between the current 'WindTrim' heading and the direction of wind shift.

- Push **Standby** and **Auto** together momentarily to accept the alarm and reset the wind shift alarm datum to the current compass heading
- Before doing so verify that the new course datum does not take the vessel into danger.

Chapter 3: Adjusting autopilot performance

3.1 Setting up Rudder Gain

The factory set rudder gain level will provide stable control for initial sea trials. However, vessels can vary widely in their response to the helm, and further adjustment to the rudder gain may improve the autopilot's steering characteristics.

- Steer onto a specific course
- Hold the course steady for 5 to 10 seconds
- Place the actuator over the tiller pin
- Press **Auto** to engage the autopilot on the current heading

In calm conditions the boat should maintain the locked heading.

The following test will check if the rudder level is set too high or too low.

In clear water and with the autopilot in 'Auto' after course to starboard by 40° by pressing the + 10 degree key four times.

Typically, at cruising speed, a course change of 40° should result in a crisp turn followed by an overshoot of no more than 2° to 5°. If this occurs the rudder gain is correctly adjusted.

An excessively high rudder setting results in oversteer which can be recognised by distinct overshoot of more than 5° (A). This condition can be corrected by reducing the rudder gain setting.

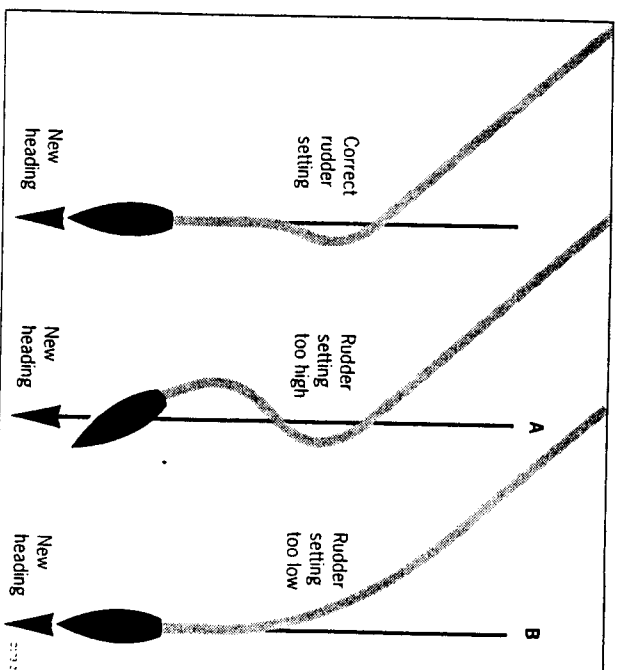

Similarly, an insufficient rudder control setting will result in understeer which gives sluggish steering performance (B). If the vessel takes a long time to make the turn and there is no overshoot then the rudder setting is too low.

These actions are most easily recognised in calm sea conditions where wave action does not mask basic steering performance.

Refer to chapter 4 – 'Autopilot re-calibration', for instructions on how to adjust the rudder gain setting.

Repeat the test until a crisp course change with no more than 2° to 5° of overshoot is achieved.

The rudder control setting is not over critical and should be set to the lowest setting consistent with accurate course keeping. This will minimise actuator movements and hence reduce power consumption and wear and tear generally.



3.2 Setting up Automatic Trim

The trim level setting determines the rate at which the autopilot applies 'Standing helm' to correct for trim changes caused by varying wind loads on the sails or superstructure. Depending on the vessels dynamic stability an incorrect rate of trim application may result in poor course keeping due to autopilot instability. The following is a guide to recommended settings. After gaining experience with the ST4000 it is considered that a higher or lower trim level setting will give improved steering performance the level may be changed in calibration and the effect evaluated. Refer to chapter 4 – 'Autopilot re-calibration', for instructions on how to adjust the automatic Trim setting.

Trim Level	Boat Type	Decrease Trim level if:	Increase Trim level if:
0			
1	Sail – Med/Heavy Displacement. Full keel/Transom rudder		Autopilot reacts slowly to heading change due to change of heel angle
2	Sail – Mod/Light Displacement	Autopilot gives unstable course keeping or excessive drive activity with change of heel angle	Autopilot reacts slowly to heading change due to change of heel angle
3	Sail – Ultra light displacement	Autopilot gives unstable course keeping or excessive drive activity with change of heel angle	

Chapter 4: Autopilot re-calibration

The ST4000 can be adjusted to meet the characteristics of your vessel and steering system.

The calibration routine allows the following parameters to be adjusted from their factory default settings.

- Rudder gain (Value on power up)
- Rudder offset adjustment
- Rudder limit
- Rate of turn limit
- Off course alarm limit
- Automatic Trim adjustment delay
- Northerly/Southerly turning error compensation

The autopilot also requires certain other information:

- Average cruise speed
- Type of steering system
- Local variation

This section will look at each feature in-turn and explain how to fine tune it to suit your particular boat.

4.1 Entering calibration mode

- Press the **Standby** button for 5 seconds until the display shows:

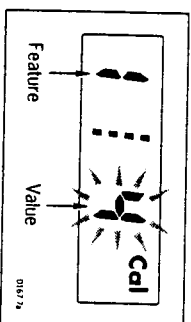

The number on the left identifies the feature (see table in section 4.3) and the number on the right the selected value for that feature.

Each feature can be cycled through using the **Auto** key.

The existing values can be viewed at any time without alteration, a simple momentary push of the **Standby** key will return the pilot to its normal operating mode without affecting the previous settings.

Note: if on entering calibration the display shows:

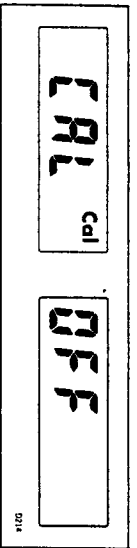

Please refer to 'Disabled calibration access' – section 4.5 for details on how to adjust.

4.2 Exiting calibration mode

You can exit calibration at any time in one of two ways:

- Press **Standby** for 1 second
This will enter any adjusted values into memory.
- Momentarily press **Standby**
This will exit calibration without entering any adjusted values into memory.

4.3 Suggested initial calibration settings

Listed below are suggested calibration settings. These will provide safe performance for the initial sea trial.

If you change any of the settings you can record them in the 'Adjusted Values' column for future reference.

Feature no	Feature	Factory setting	Adjusted Values
1	Rudder Gain	5	
2	Rudder Offset	0	
3	Not applicable		
4	Turn rate limit	20	
5	Average Cruise speed	8	
6	Off course alarm angle	20	
7	Trim level	1	
8	Steering system type	1 (Set to 3 if a rudder reference transducer is fitted)	
9	Local magnetic variation	Off	
10	North/South turning error correction	0 – Off 1 – Northern Hemisphere 2 – Southern Hemisphere	
11	Current vessel Latitude	xx	
12	Not available		
13	Rudder damping	1	

Note: Level 12 is not available on the ST4000 tiller autopilot.
If level 10 is set to 0 then level 11 will be omitted.

4.4 Calibrating the autopilot to suit your boat

Calibrate the pilot as follows:

- Enter calibration mode as described in section 4.1.

The display will show:



Calibration Level 1 (Rudder Gain)

Calibration level 1 is Rudder gain. This requires setting up whilst under way. Please refer to Rudder gain adjustment in chapter 3.

Calibration Level 2 (Rudder Offset)

Calibration level 2 is 'Rudder offset'. This will only require setting if your installation includes a rudder reference transducer.

- Press the **Auto** key



Manually place the helm in a central position. Use the +1 and -1 degree keys to adjust the rudder angle reading on the right hand side of the display to zero.

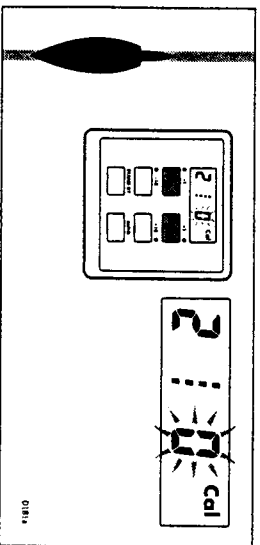

Calibration Level 3

Calibration level 3 does not require setting on the ST4000 linear autopilot.

- Press the **Auto** key

Calibration Level 4 (Turn Rate Limit)

Calibration level 4 is Turn Rate Limit. This will limit the rate of turn of your vessel when under autopilot control.

- Press the **Auto** key



For sailboat applications it should be set to 20°.

- Setup turn rate limit with the +1 and -1 degree buttons

Calibration Level 5 (Cruise Speed)

Calibration level 5 sets the boat's normal cruising speed for use in 'Track Control'.

- Press the **Auto** key



When interfacing with Radio navigation systems the Control head uses the vessel's average cruising speed to perform track calculations.

Adjust the cruise speed with the +1 and -1 degree buttons.

Note: If an ST50 Speed or Tridata instrument is connected to the SeaTalk bus they will transmit boat speed information directly to the control head.

Calibration Level 6 (Off course alarm angle)

Calibration level 6 is Off course alarm angle. This is an alarm to warn you if the autopilot is unable to maintain its set course.

- Press the **Auto** key



The off-course alarm operates if the autopilot strays off course by more than the alarm angle limit for more than 20 seconds. This limit can be set in 1° increments anywhere between 15° and 40° using the +1 and -1 degree course change buttons.

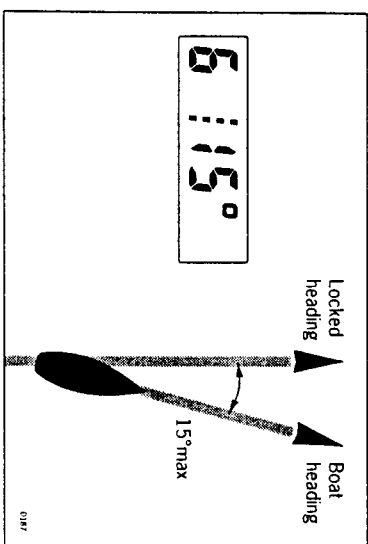

Calibration Level 7 (Trim Level)

Calibration level 7 selects and sets the level for automatic trim. This applies additional rudder to correct for weather helm.

- Press the **Auto** key

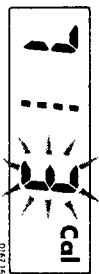

Trim can be set to one of three rates or switched off completely.

- Level 0 Trim off
- Level 1 Slow trim correction
- Level 2 Medium trim correction
- Level 3 Fast trim correction. (Recommended for ultra light displacement boats)

Adjust the trim level using the +1 and -1 degree buttons.

Refer to section 3.2 for further information.

Calibration Level 8 (Steering system type)

Calibration level 8 is only setup if a rudder reference transducer is included in the installation.

- Press the **Auto** key



1. Without rudder reference transducer
2. Not applicable
3. With rudder reference transducer
4. Not applicable

Select the correct drive using the +1 and -1 degree keys.

Calibration Level 9 (Magnetic variation)

Calibration level 9 tells the pilot the level of magnetic variation present at the boats current position.

- Press the **Auto** key



You should enter your local variation using +1 and -1 degree keys. This value will then be transmitted onto the SeaTalk bus and picked up by the SeaTalk instruments such as the Multi repeater.

Note: +ve variation: East

-ve variation: West

Calibration Level 10 (Northerly/Southerly heading error correction)

Calibration level 10 allows Northerly or Southerly heading error correction to be switched in.

It may be noticed that the autopilot tends to be a little less stable on northerly headings in the higher latitudes of the Northern hemisphere (and conversely southerly headings in the Southern hemisphere). This is caused by the increasing angle of dip of the earth's magnetic field at higher latitudes which has the effect of amplifying rudder response on northerly (southerly) headings. This error affects all magnetic compasses and gets worse the further away from the equator you are.

The ST4000 is able to compensate for this and provide precise course keeping on all headings by automatically adjusting the gain of the autopilot depending on heading.

- Press the **Auto** key



Use the **+1** and **-1** degree keys to select:

0 = Off

1 = Northern Hemisphere

2 = Southern Hemisphere

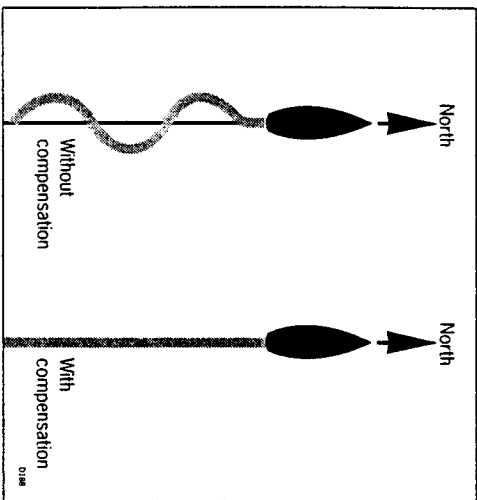

Calibration Level 11 (Current Vessel Latitude)

Calibration level 11 requires the boat's current latitude (to the nearest degree) in order to compensate for Northern/Southerly heading error.

- Press the **Auto** key



- Set up latitude using the **-1** and **+1** degree keys

Note: If the correction is set to 0 in Calibration Level 10 then level 11 will be omitted and pressing the Auto key in Calibration Level 10 will move the display directly onto level 13 (level 12 is omitted on the ST4000).

Calibration Level 12 (Not available with the ST4000)

This level is not available with the ST4000 Autopilot.

Calibration Level 13 (Rudder Damping)

Level 13 only requires setting up if the installation includes a rudder reference transducer and the drive 'hunts' when trying to position the rudder.

- Press the **Auto** key



Calibration level 13 allows 1 of nine levels of rudder damping to be selected. This should always be set to 1 initially.

Rudder damping should be set-up as follows:

- Exit calibration by pressing the **Standby** key for 1 second until the display shows:

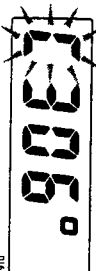

Note: A momentary push will give the same display but will not store the previously calibration steps.

- Place the actuator over the tiller pin
- Press the **Auto** key
- Press the **+10** degree course change key once

Observe the tiller movement. If the rudder appears to position and then hunt e.g. drive port and then starboard in small jerky movements then return to calibration level 13 and increase the rudder damping level by one, using the **+1** and **-1** degree buttons, and repeat the test until the rudder positions without hunting.

Note: It is most important that the rudder damping level is set as low as possible for best possible course keeping.

The calibration should now be saved by pressing the **Standby** key for 1 second.

4.5 Disabled calibration access

It is possible to disable the calibration set-up to prevent unauthorised access.

This is achieved as follows:

- Press and hold the **-1** and **Standby** keys for 10 seconds until the display shows:

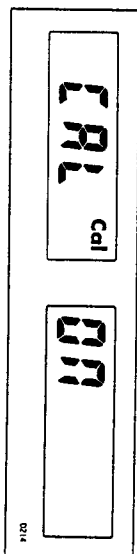

- Toggle the calibration access on and off using the **-1** and **+1** degree keys
 - Store the setting by pressing the **-1** and **Standby** keys for 10 seconds until the control head returns to normal operation
- If preferred this page can be removed from the handbook after access has been switched off.

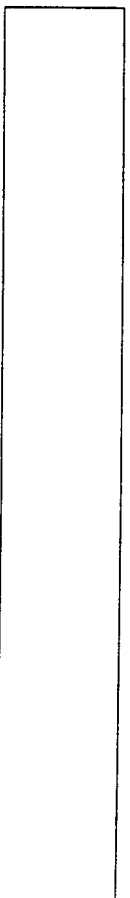
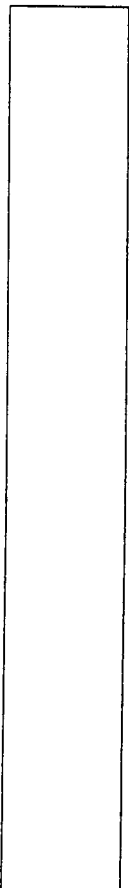

Installation



Contents

Chapter 5: Installation	45
5.1 Control head	45
Siting	45
Mounting procedure	45
Cable connectors	46
Power supply connection	47
Connection to the SeaTalk bus	48
5.2 Fluxgate Compass	49
Mounting position	49
Cabling	51
5.3 Rudder Reference Transducer	51
Mounting position	51
Control dimensions	53
Cabling	53
5.4 Linear Actuator	54
Porthand mounting	55
Basic installation	56
Tiller pin installation (cat no D001)	56
Mounting socket installation (cat no D002)	56
Installation accessories	57
Pushrod extensions	57
Tiller brackets	58
Cantilever mounting	60
Pedestal socket mounting	62
Tiller pins	64
Cabling and Socket Installation	64
Cabling	64
Socket installation	65
Chapter 6: Interfacing to GPS, Decca, Loran, Wind	67
6.1 Cabling	67
6.2 NMEA data transmission to other equipment	67
6.3 Data formats	68
Chapter 7: Functional Test and Initial Sea Trial	69
7.1 Functional test	69
Switch on	69
Operating sense	69
Rudder reference phase	70
Navigation interface (GPS, Decca, Loran)	70
Wind transducer interface	71
SeaTalk bus	72
7.2 Initial Sea trial	72
Automatic Compass deviation correction	73
Autopilot operation	74
Chapter 8: Accessories	76
Chapter 9: Maintenance	78
Control head	78
Drive unit	78
Cabling	78
Chapter 10: Fault Finding	79

Chapter 5: Installation

5.1 Control head

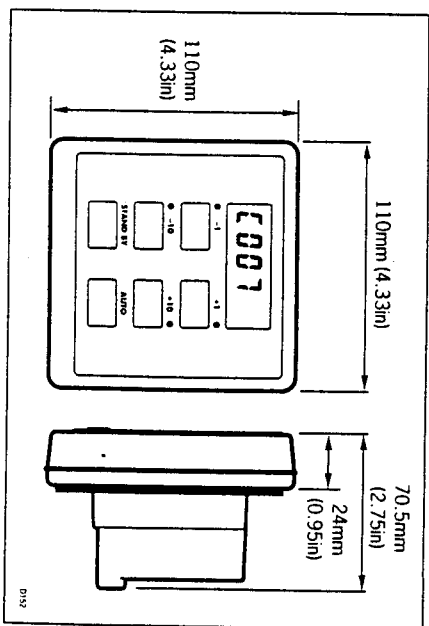

Siting

The ST14000 control head is totally waterproof and should be sited where

- It can easily be reached from the steering position
- Protected from physical damage
- At least 230mm (9in) from a compass
- At least 500mm (20in) from radio receiving equipment
- Accessible from behind to secure and run cables

Note: The back cover is designed to breathe through the cable boss to prevent moisture accumulation. This must be protected from the weather by following the Mounting procedure.

Mounting procedure

The surface must be smooth and flat.

- Use the template provided to mark the centers of the two fixing holes and cable boss

Note: Adjacent Control heads and ST150 instruments should have 6mm (0.25in) separation to allow room for the protective covers.

- Drill to 4mm (0.16in) diameter
- Use a 70mm (2.75in) diameter cutter to drill the hole for the center boss (1)

- Screw the two fixing studs (2) into the back cover
 - Pass the cables through the central hole
 - Attach the wiring loom to the terminals on the rear of the ST4000 (see later sections)
 - Attach the harness protection cover using the central screw provided
 - Secure the Control head with the thumb nuts provided (3)
- A sealing gasket (4) is already attached to the back cover of the Control head.

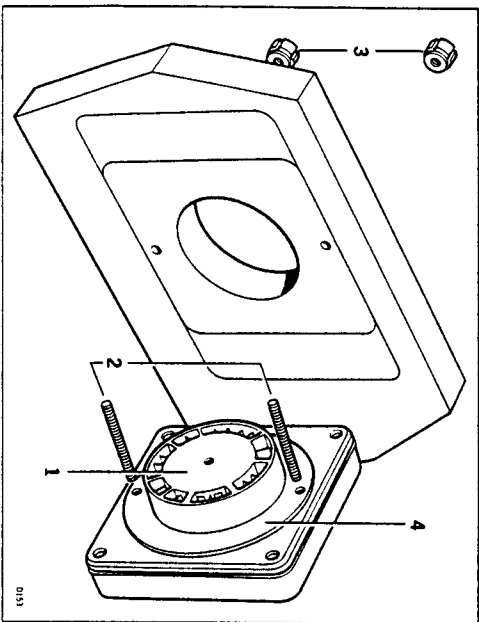

Cable connectors

All electrical connections to the ST4000 are made via spade connectors on the rear case. When installing each spade connector make sure the connector fits securely over the blade and not between the connector and its plastic insulating boot. This will give an intermittent connection and faulty autopilot operation.

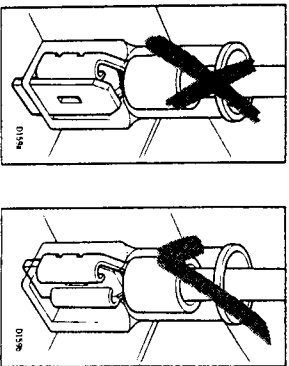

Power supply connection

The ST4000 requires its own dedicated power supply as it cannot source power from the Sea Talk bus. A 2m (6.5ft) power lead is supplied for this purpose and is terminated with 1/4in spade connectors. A 12A circuit breaker or fuse should be fitted as shown below.

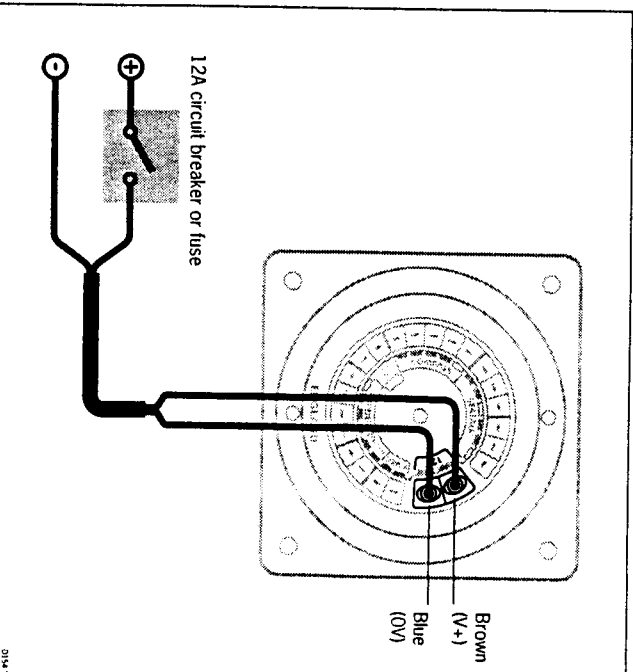

The lead can be extended if required. The following table shows the minimum cable sizes acceptable:

Cable length	Copper area	AWG
Up to 2.5m (8ft)	1.5mm ²	16
Up to 4.0m (13ft)	2.5mm ²	14

Important!

Correct cable size is critical for correct autopilot operation. The cable you choose may meet the required current specification but, if too small, will drop voltage between the supply and the control head. This will reduce the power of the actuator.

Connection to the SeaTalk bus

The ST4000 is supplied with one SeaTalk cable tail. This can be connected to the spade connectors marked 'SeaTalk' on the rear of the Control head as shown below:

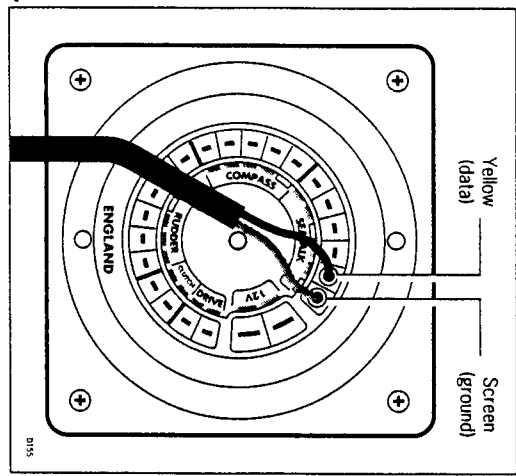

Other SeaTalk instruments can now be connected to the control head using a SeaTalk extension cable (see chapter 8 – 'Accessories').

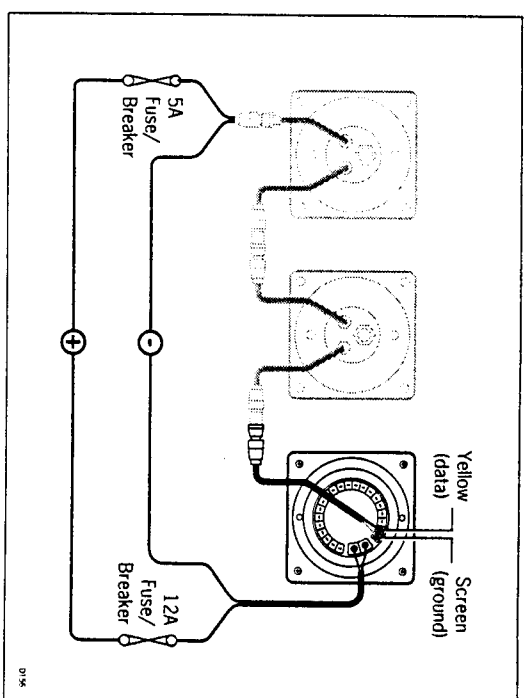

For safety reasons the ST4000 should not supply power to the SeaTalk bus. Any SeaTalk instruments fitted must be powered via a separate 5A fuse/breaker as shown using the power lead supplied with the instruments.

5.2 Fluxgate Compass

Mounting position

The fluxgate compass should be attached to a convenient vertical surface using the self tapping screws provided. There is no need to orient the fluxgate compass fore and aft. Heading alignment is carried out electronically.

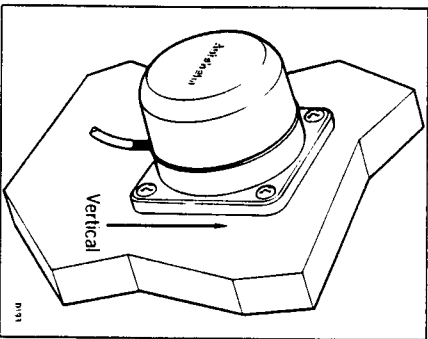

Correct positioning of the fluxgate is crucial if ultimate performance from the autopilot is to be achieved. The fluxgate should ideally be positioned as near as possible to the pitch and roll centre of the vessel in order to minimise gimbal disturbance.

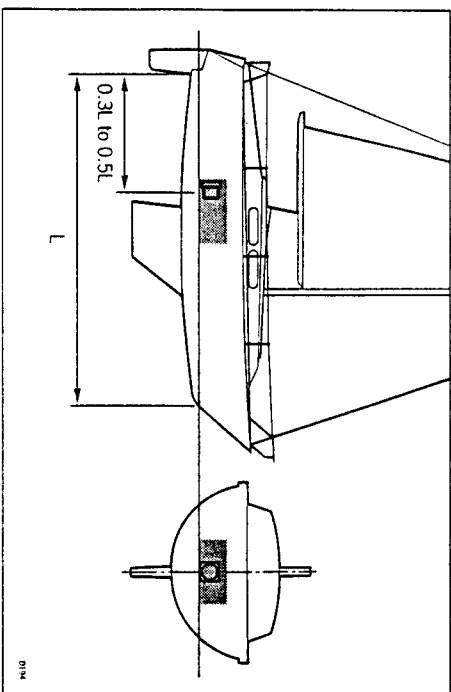

It is very important to ensure that the fluxgate is positioned at least 0.8m (2.5ft) away from the vessel's steering compass in order to avoid deviation of both compasses. The fluxgate must also be positioned as far away as possible from large iron masses, such as the engine and other magnetic devices which may cause deviation and reduce the sensitivity of the sensor. If any doubt exists over magnetic suitability of the chosen site, the position may be surveyed using a simple hand bearing compass. The hand bearing compass should be fixed in the chosen position and the vessel swung through 360°. Relative differences in reading between the hand bearing compass and the vessel's main steering compass should ideally not exceed 20° on any heading.

Cabling

Once the fluxgate has been positioned the cable should be led back to the control head. The cable has five tails each of which is fitted with a spade connector. These should be connected colour for colour to the 'Compass' section at the rear of the unit as shown below:

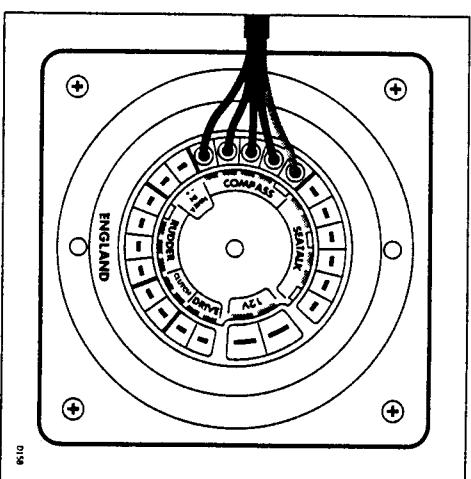

5.3 Rudder Reference Transducer

A rudder reference transducer can be used to provide a readout of rudder angle. It is available as an accessory (cat no Z1 31).

Mounting position

The rudder reference unit must be mounted on a suitable base adjacent to the rudder stock using the self tapping screws provided. The base height must ensure correct vertical alignment of the rudder reference unit arm and tiller arm. If it is more convenient, the rudder reference unit may be mounted upside down (logo downwards), but if this is done, the red and green wires from the transducer must be reversed on the rear of the Control head.

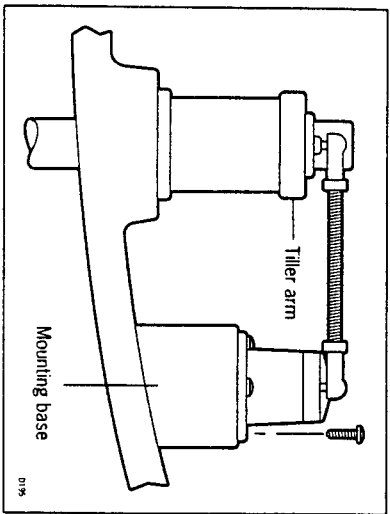

The rudder reference unit has a built in spring to remove any free play in the linkage to the tiller. This gives very precise rudder position.

The rudder reference arm movement is limited to $\pm 60^\circ$. Care must be taken during installation to ensure the rudder reference arm is opposite the cable entry when the rudder is amidships. Failure to do this could result in damage if the rudder reference arm is driven onto its end stops by the steering system.

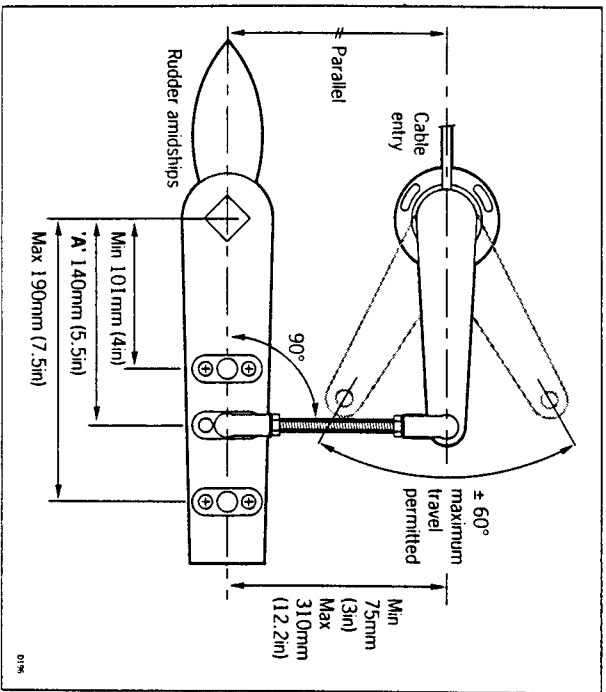

Control dimensions

It is important to ensure that the dimensions set out below are within the limits set and the tiller arm and rudder reference arm are parallel to each other.

With the rudder amidships, the rudder reference arm should be opposite the cable entry and at 90° to the connecting bar. Minor adjustment can be made by slackening off the 3 securing screws and rotating the transducer body.

The tiller pin must be positioned within the limits shown. Ideally dimension 'A' should be 140mm (5.5in). However, changing this within the limits shown will not degrade the autopilot performance but will slightly alter the scaling of the rudder angle display. The tiller pin is secured to the tiller arm using the self tapping screws provided.

Cut the studding to length and screw on the lock nuts and ball pin sockets. The sockets can then be pressed onto the pins. Move the rudder from side to side to ensure the linkage is free from any obstruction at all rudder angles.

Cabling

Once the rudder reference has been positioned the cable should be led back to the Control head. The cable has four tails each of which is fitted with a spade connector. These should be connected colour for colour to the 'RUDDER' connections at the rear of the Control head as shown below:

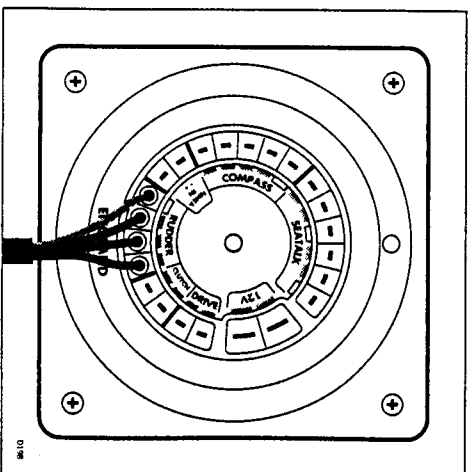

5.4 Linear Actuator

The drive unit is mounted between the tiller and a single attachment point on the yacht's structure. For correct installation two basic dimensions are critical:

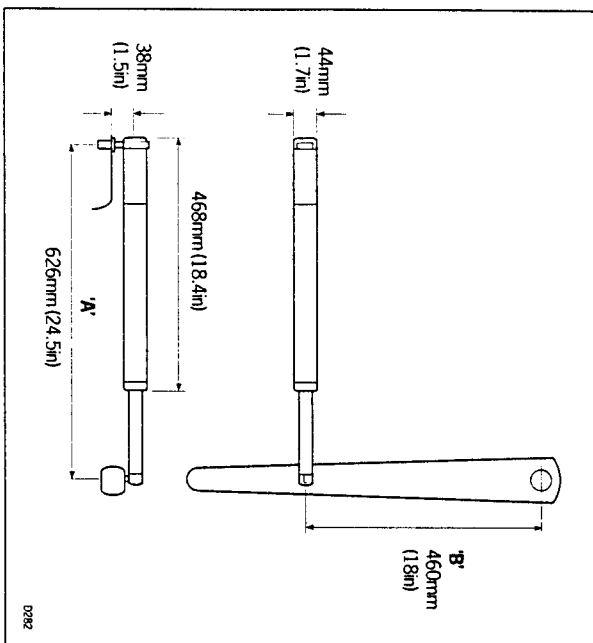

Dimension 'A' = 620mm (24.5in)
(Mounting socket to tiller pin)

Dimension 'B' = 460mm (18in)
(Rudder stock centre line to tiller pin)

Clamp the tiller on the yacht's centre line and mark off dimensions 'A' and 'B' ('A' is measured on the starboard side of the cockpit) using masking tape to locate the fixing points.

Ensure the measurements are at right angles as shown.

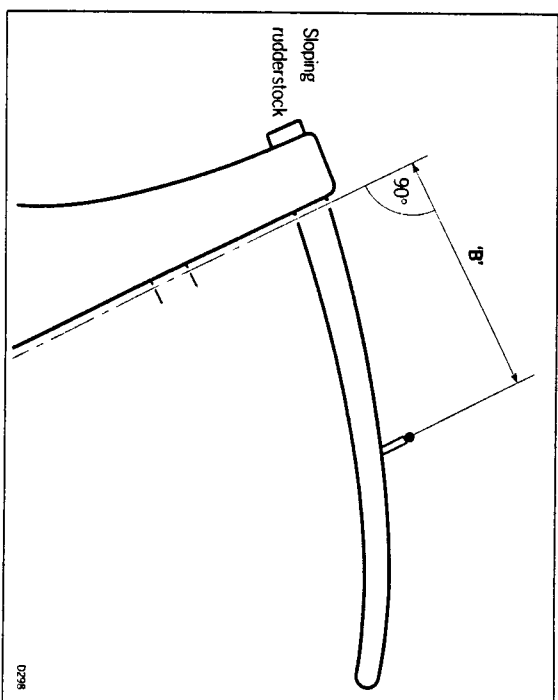

The drive unit must be mounted horizontally.

Porthand mounting

In certain circumstances it may be more convenient to mount the unit on the porthand side. This is perfectly acceptable so long as the dimensions shown for both 'A' and 'B' are correct.

Note: The Control head will require programming for port hand operation. This will be covered during the initial functional test in chapter 7.

Basic installation

After establishing the control dimensions the ST4000 can usually be mounted directly onto the starboard cockpit seat.

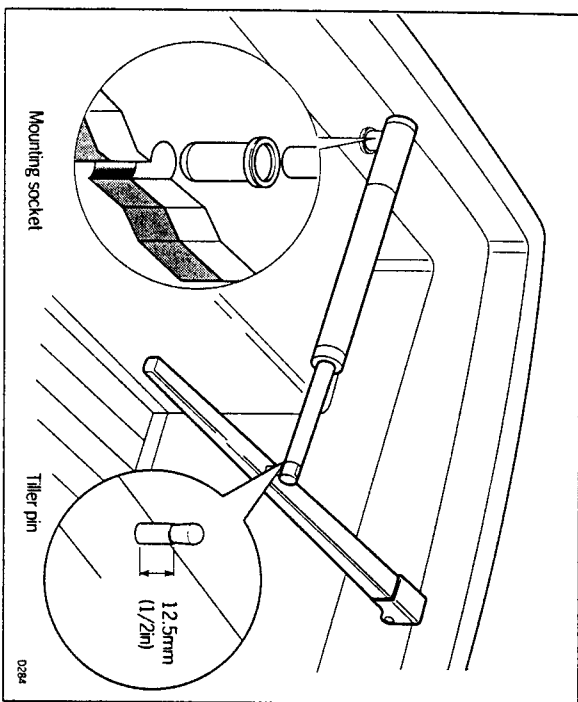

Proceed as follows:

Tiller pin installation (cat no D001)

- Drill 6mm (1/4in) hole x 25mm (1in) deep at point marked.
- Using a two part epoxy such as araldite, epoxy the tiller pin into place
- Position the shoulder of the pin 12.5mm (1/2in) above the tiller surface

Mounting socket installation (cat no D002)

- Drill 12.5mm (1/2in) hole x 25mm (1in) deep into the starboard cockpit seat
- If the structure thickness at the mounting position is less than 25mm (1in) carefully reinforce the under surface with a plywood plate bonded into position

- Install the mounting socket using two part epoxy adhesive

Note: The autopilot is capable of generating high pushrod loads ensure that:

- The epoxy is allowed to harden thoroughly before applying any loads
- All holes are drilled to correct size and where necessary reinforcing is

provided

Installation accessories

If it is not possible to install the drive unit directly onto the cockpit seat or tiller as described, one of the following accessories (or combination) will ensure a perfect installation.

Pushrod extensions

The pushrod length may be simply extended using one of the standard pushrod extensions.

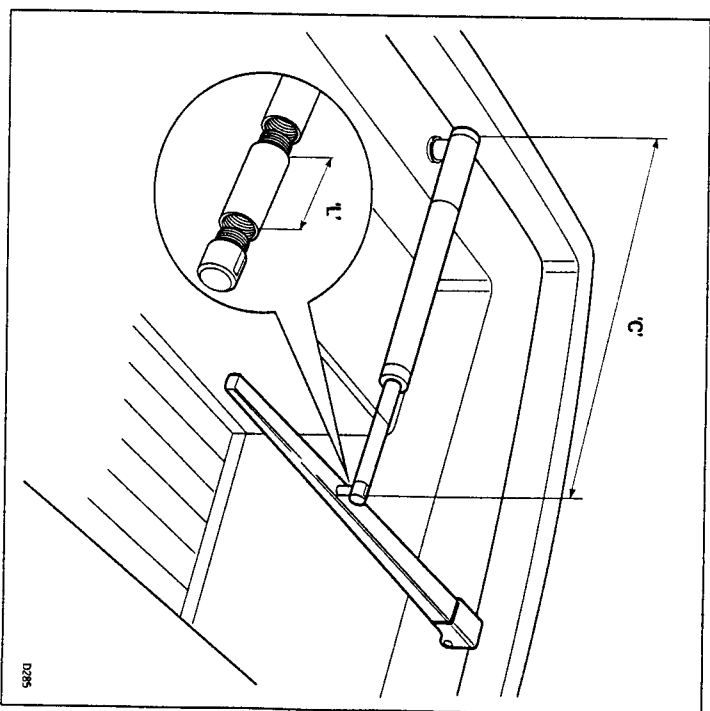

Dimension 'c' is modified as follows:

Dimension C	Pushrod Extension Length L	Cat No
622mm (24.5in)	std dimension -	
648mm (25.5in)	25mm (1in)	D003
673mm (26.5in)	51mm (2in)	D004
699mm (27.5in)	76mm (3in)	D005
724mm (28.5in)	102mm (4in)	D006
749mm (29.5in)	107mm (5in)	D007
775mm (30.5in)	152mm (6in)	D008

Tiller brackets

Where the height of the tiller above or below the cockpit seat or mounting plane is such that standard mounting is not practical a range of tiller brackets allows the tiller pin offset to be varied.

- Position the tiller bracket on the centre line (upper/lower) of the tiller and establish control dimensions 'A' and 'B'.
- Mark off the position of the centres of the two fixing bolt holes
- Drill two 6mm (0.25in) diameter clearance holes through the centre line of the tiller
- Install the tiller bracket using 2 x 6mm (0.25in) diameter bolts, nuts and washers
- Bond the fixing bolts in place with epoxy adhesive and fully tighten the nuts

Dimension D (below tiller)	Dimension E (above tiller)	Cat No
25mm (1in)	51mm (2in)	D009
51mm (2in)	76mm (3in)	D010
76mm (3in)	102mm (4in)	D011
102mm (4in)	127mm (5in)	D012
127mm (5in)	152mm (6in)	D013

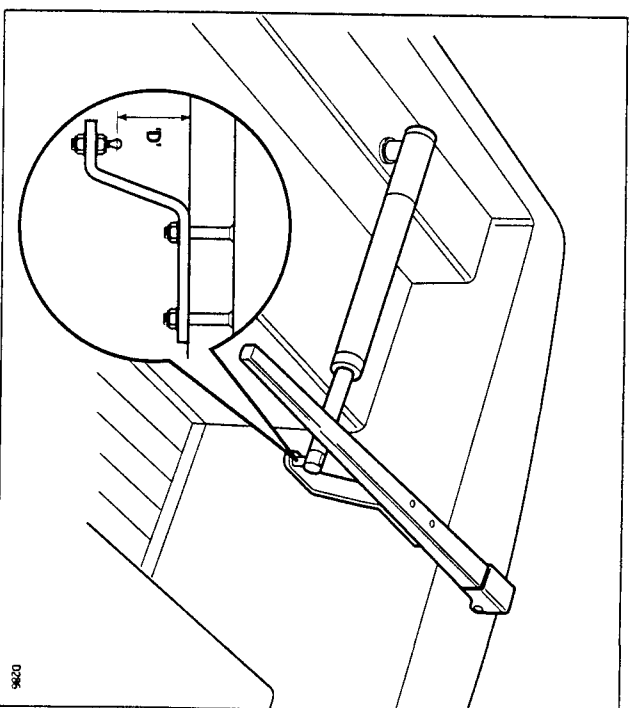

0286

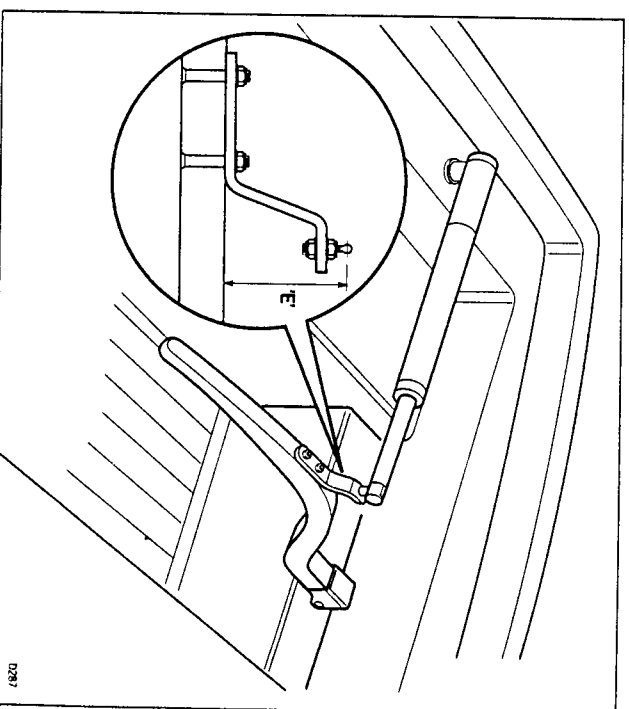

0287

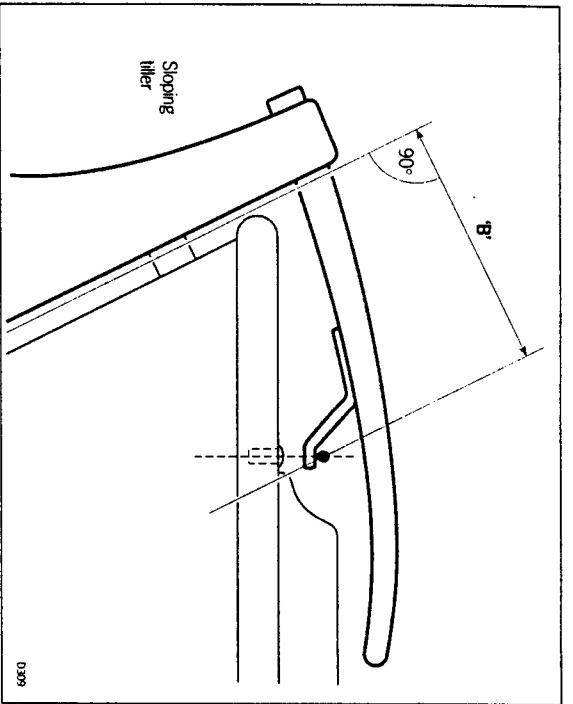

Cantilever mounting

Where it is necessary to attach the autopilot to a vertical face such as the cockpit sidewall a cantilever socket assembly is used.

The maximum extension offset is 254mm (10in) and the cantilever can be cut to the exact length necessary during mounting.

- Clamp the tiller on the yacht's centre line
- Measure dimension 'F' (actual)
- Refer to table to establish cutting length for cantilever rod (double check measurements before cutting).
- Cut cantilever rod to length 'L' using a hacksaw. **Measure from threaded end**
- Remove burrs with file
- Temporarily assemble the cantilever by screwing the rod into the mounting flange
- Ensure the drive unit is horizontal and mark off the location of the mounting flange
- Mark and drill 3 x 6mm (1/4in) clearance holes (ignore the two inner holes)

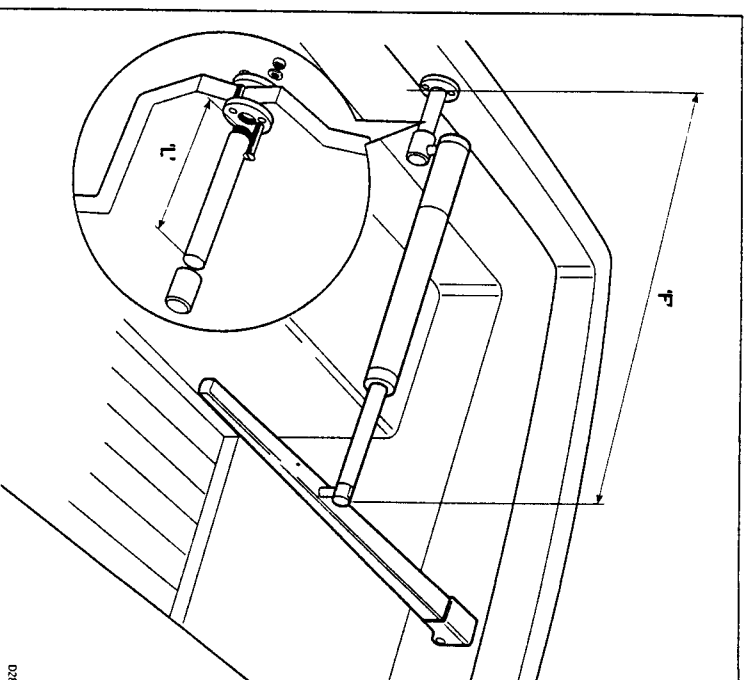

Dimension F	Cut length L
686mm (27in)	51mm (2in)
711mm (28in)	75mm (3in)
737mm (29in)	102mm (4in)
762mm (30in)	127mm (5in)
787mm (31in)	152mm (6in)
813mm (32in)	178mm (7in)
838mm (33in)	203mm (8in)

- Mount the flange using 3 x 6mm (1/4in) diameter bolts with nuts and washers. Be sure to install the backing plate correctly, bed the flange on a thin coat of silicone sealant.
- Screw the rod firmly into place using a tommy bar
- Roughen the end of the rod and the inside of the cap to provide a key
- Apply the two part epoxy adhesive provided to the rod end and cap and place the cap over the rod end
- Ensure the hole for the drive unit mounting pin is facing up
- Allow the epoxy adhesive 30 minutes to fully harden before applying any load

When the Autohelm is not in use the complete rod assembly may be unscrewed, leaving the cockpit unobstructed.

Pedestal socket mounting

It may be necessary to raise the height of the drive unit mounting socket above the mounting surface, for this a pedestal socket assembly is used.

- Lock the tiller on the yacht's centre line
- Establish the standard control dimensions 'A' and 'B'
- Measure dimension 'G' ensuring the autohelm actuator is horizontal
- Select the appropriate pedestal socket assembly from the table shown

Installation

- Mark off the position of the mounting flange on the cockpit seat or counter
- Ensure that control dimensions 'A' and 'B' are correct
- Mark and drill 3 x 6mm (1/4in) diameter clearance holes (ignore the two inner holes)
- Mount the flange using 3 x 6mm (1/4in) diameter bolts, nuts and washers, being sure the back plate is installed correctly. Bed the flange on a thin coat of silicone rubber sealant.
- Screw the mounting socket firmly into place

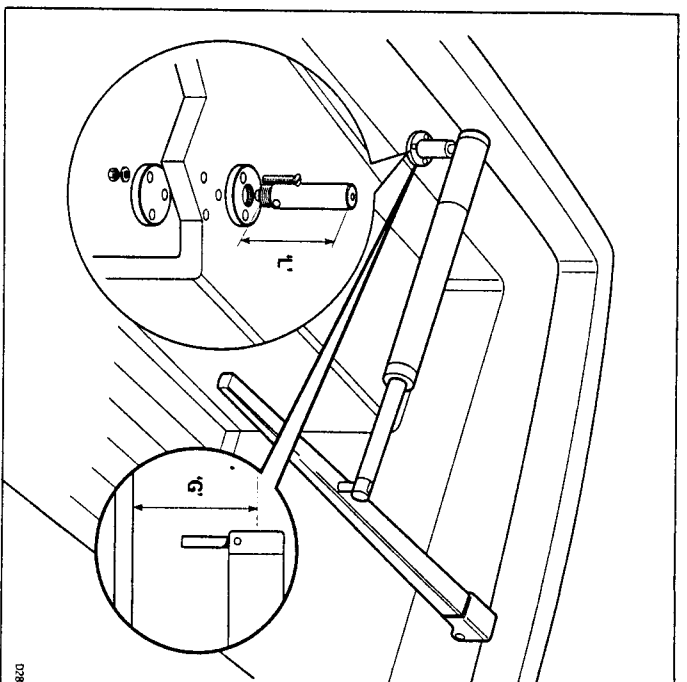

When the Autohelm is not in use the mounting socket may be unscrewed to leave the cockpit unobstructed.

Dimension G	Pedestal socket length L	Cat No
38mm (1.5in)	std dimension-	
76mm (3in)	38mm (1.5in)	D026
89mm (3.5in)	50mm (2in)	D027
102mm (4in)	64mm (2.5in)	D028
114mm (4.5in)	76mm (3in)	D029
127mm (5in)	89mm (3.5in)	D030

Tiller pins

For certain non-standard installations a range of tiller pins is available.

Description	Size	Cat No
Small threaded tiller pin	25mm (1in)	D014
Extra length tiller pin	27mm (2.8in)	D020
Extra length threaded tiller pin	72mm (2.8in)	D021

Cabling and Socket Installation

The actuator is connected to the Control head using a water proof plug and socket. The plug comes ready assembled to the actuator. The socket should be mounted in the cockpit area next to the actuator.

Cabling

Using the following table as a guide, route cable of a suitable size from the rear of the socket back to the Control head.

Cable length	Copper area	AWG
Up to 2.5m (8ft)	1.0mm ²	18
Up to 4.0m (13ft)	1.5mm ²	16
Up to 6.5m (22ft)	2.5mm ²	14

Using a suitable tool, crimp the spade receptacles supplied to the cables and connect, colour for colour, to the 'drive' connections on the rear of the Control head.

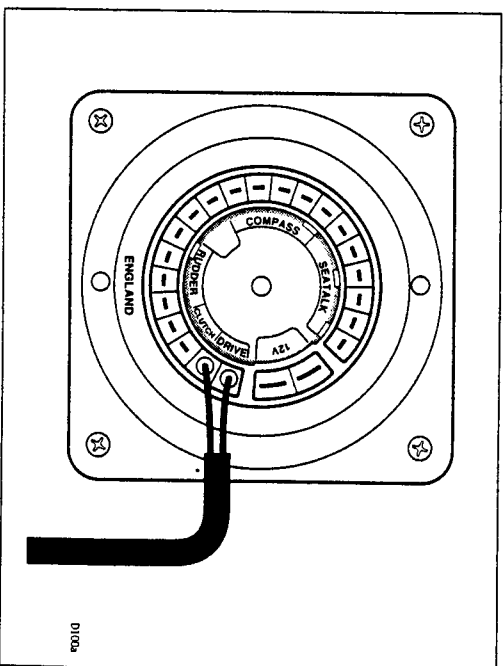

Socket installation

The socket is assembled as follows:

- Fix the self adhesive template onto the bulkhead at the selected socket location
- Carefully drill the 18mm (23/32in) clearance hole and 2.4mm (3/32in) pilot holes. Remove the template
- Fit the plug cap (1) to the socket body (2) as shown
- Locate the 'O' ring seal (3) into the groove between the plug cap and socket body

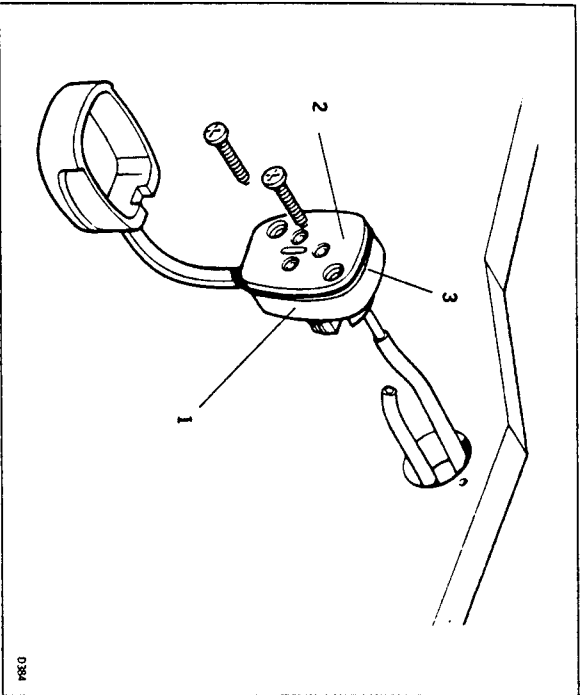

- Thread the cable through the bulkhead hole and wire into the socket as shown making sure the wires are connected to the correct pin

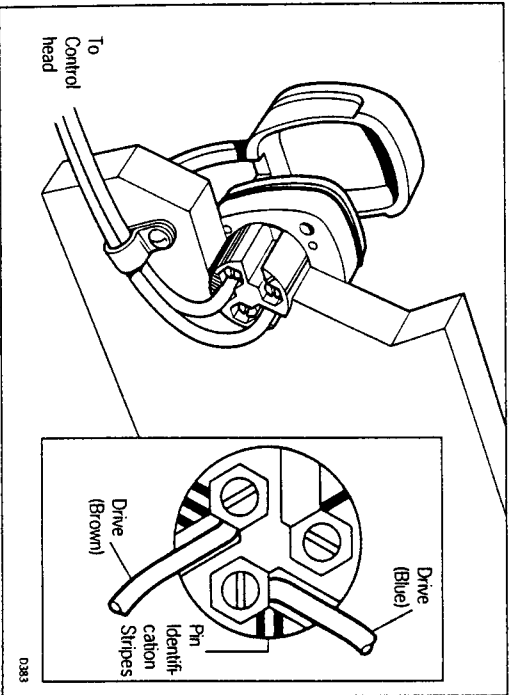

- Attach the socket to the bulkhead using the two self tapping screws supplied
- Restrain cables as shown

Chapter 6: Interfacing to GPS, Decca, Loran, Wind

The ST4000 will accept navigation data in the NMEA format for use in 'Track Control' and 'Windvane' mode. The required data formats are shown in section 6.3.

6.1 Cabling

The NMEA data port is on the rear of the ST4000 and should be connected to a Position transducer or wind instrument as shown:

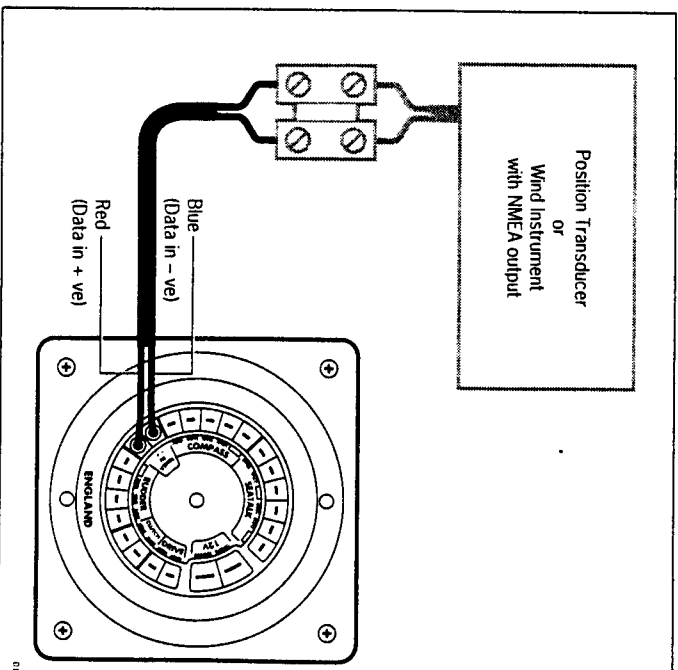

6.2 NMEA data transmission to other equipment

If you wish to transmit NMEA information to other equipment a SeaTalk interface (cat no Z137) should be installed as shown:

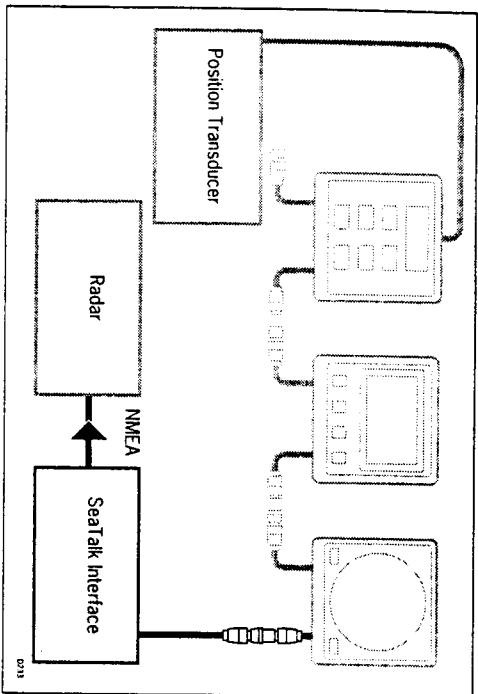

6.3 Data formats

The following NMEA 0183 wind and navigation data can be decoded by the ST4000.

Data	NMEA 0183
Latitude and Longitude	GLL,RMC,RMA,IMA,GLP,GOP,GXP,GDP, GLF,GOF,GXF,GDF,GGA,GLA, GOAGXA,GDA
Course over the ground	VTG,VTA,RMC,RMA
Speed over the ground	VTG,VTA,RMC,RMA
Cross Track Error	APB,APA,RMB,XTE,XTR
Bearing to Waypoint	APB,BPI,BWR,BWC,BER,BEC,RMB
Distance to Waypoint	WDR,WDC,BPI,BWR,BWC,BER,BEC,RMB
Waypoint Number	APB,APA,BPI,BWR,WDR,BWC,WDC,RMB, BOD,WCV,BER,BEC
Wind heading / Speed	VWR
Variation	HVM,RMC,RMA,HVD

NMEA 0180 cross track error information is also acceptable for operation in 'Track Control'. However, as waypoint distance, bearing and number are not transmitted these cannot be displayed.

Chapter 7: Functional Test and Initial Sea Trial

This section of the handbook consists of a set of simple tests followed by short sea trial. This will confirm that the system is wired correctly and is also setup to suit your type of boat.

7.1 Functional test

Switch on

Having installed your ST4000 tiller autopilot, switch on the main power breaker.

The control head should beep and display ST4000. Within 2 seconds a compass heading preceded by a flashing 'C' should be displayed e.g. 'C'234. This shows the control head is active. If the head does not beep please refer to chapter 10 – 'Fault finding'.

Operating sense

The operating sense of the autopilot defines the direction helm will be applied when a course change button is pressed or the vessel goes off course. It can be checked as follows:

- Place the actuator over the tiller pin
- Press +10°

The tiller should move to produce a turn to Starboard. If it moves to port then the autopilot phase should be reversed by following the procedure on page 75.

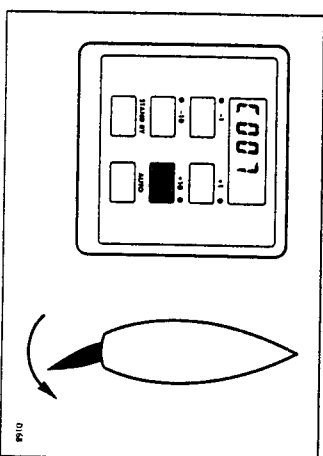

Rudder reference phase

This should only be carried out if a rudder reference transducer is fitted.

Enter calibration mode as described in chapter 4 and adjust calibration level 8 (Steering system type) to 3. Store calibration by pressing the **Standby** key for 1 second.

Check the rudder reference cabling and phase as follows:

- Press **+1** degree and **-1** degree buttons together for 1 second. The display will now indicate rudder angle.
 - Move the helm to its center position.
- The display should now indicate within $\pm 7^\circ$. If this is not the case then the rudder reference mounting bolts should be slackened and the base rotated until it does. Final adjustment to accurately set up the display and helm is carried out in the 'autopilot calibration' section of this handbook.
- Turn the helm to produce a turn to starboard

The rudder angle display should increase in a positive direction.

If instead it increases in a negative direction reverse the rudder reference green and red wires on the rear of the Control head and re-check the above test.

Navigation interface (GPS, Decca, Lorain)

If the ST4000 is interfaced to a position transducer, via its NMEA data port, then the position transducer must be set up to transmit data as detailed in section 6.3.

The interface can be simply checked as follows:

- Set up a Track on the position transducer to give a cross track error of between 0 and 0.3nm
 - Enter 'Auto' mode by pressing the **Auto** key
 - Enter 'Track' mode by pressing the **+10** and **-10** degree keys together
- After 3 seconds the pilot should automatically scroll through three navigation displays:



R235°



1.35
W.Pt
nm



20.23
nm

If instead it shows one of the following error displays then there is either wiring error or the position transducer is not set-up to transmit the required data format:



-
nm

This display indicates data is not being received. The most likely reason being a cabling error – either open circuit, short circuit or wires reversed.



NERR
nm

This indicates that the signals being received by the position transducer are too weak for reliable navigation. Reference should be made to the position transducer handbook for further action.

Wind transducer interface

If the ST4000 is connected to a wind instrument via its NMEA data port (not SeaTalk) then the link between the two instruments should be checked as follows:

- Press the **Standby** and **Auto** keys together
- The ST4000 should then display the locked heading preceded by a W as shown.



W202°

If the display continues to show the current heading preceded with a flashing 'C' then wind data is not being received by the ST4000.

The most likely reason being a cabling error – either open circuit, short circuit or wires reversed.

SeaTalk bus

If the ST4000 has been linked to other SeaTalk instruments via the SeaTalk bus the link can be checked as follows:

- Push **Standby** on the autopilot Control head
- Select display illumination level 3 on any other SeaTalk instrument or autopilot control unit

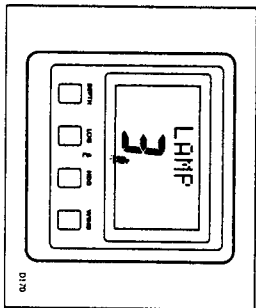

The ST4000 should immediately respond by switching on its display illumination.

If the illumination does not switch on then a cabling fault exists in the SeaTalk cabling between the ST4000 control head and the instruments/control unit.

7.2 Initial Sea trial

Having checked that the system is functioning correctly a short sea trial is now required to complete the setting up. This should be carried out in calm waters clear of any obstructions.

The ST4000 has a built-in calibration capability which enables it to be fine tuned to suit the individual vessel, its steering system and dynamic steering characteristics. As supplied from the factory the unit is calibrated to provide safe stable autopilot control for the majority of vessels (see section 4.3).

Before carrying out the first sail trial it is recommended that the calibration levels be checked and if necessary reset to the recommended levels.

This procedure will only take a minute or so and full details are given in chapter 4.

- Do not attempt to make any permanent change to the recommended calibration values until a sail trial has been carried out

- It is important that the initial sail trial is carried out in conditions of light wind and calm water so that autopilot performance can be assessed without the influence of strong winds or large waves

Note: At any time during the sea trial you can lift the actuator off the tiller pin to return to hand steering.

Automatic Compass deviation correction

The ST4000 will correct the fluxgate compass for most deviating magnetic fields. **Before carrying out the initial sail trial it is vital to carry out the Compass Deviation Correction.** Failure to do so may result in the autopilot performance being impaired on some compass headings. This procedure should be carried out in calm conditions preferably in flat water.

Select compass correction as follows:

- Push and hold **Standby** for 1 second



046/72

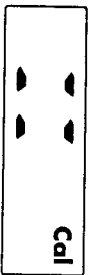

046/72

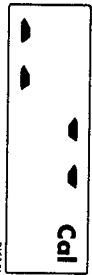

046/72

Keeping boat speed below 2 knots and using the +10° and -10° keys to control the rudder angle, turn the vessel slowly, in a circle, so that it takes at least 3 minutes to complete 360°. Keep turning until the display changes to show the amount of deviation the autopilot has detected. Deviation and current vessel heading will alternate every 1 second.



046/72



046/72

Note: If the amount of deviation exceeds 15°, it is recommended the fluxgate is re-sited.

Use the +1° and -1° course change keys to increase or decrease the displayed heading until it agrees with the ship's steering compass or a known transit bearing.

Exit compass adjust and store the compass correction/alignment as follows:

- Push and hold **Standby** for 1 second
- or, to exit compass adjust without saving any new settings
- Push **Standby** momentarily

Autopilot operation

Having calibrated the compass the following procedure is recommended to familiarise yourself with autopilot operation:

- Steer onto a compass heading and hold the course steady
- Place the actuator over the tiller pin
- Push **Auto** to lock onto the current heading. In calm sea conditions a constant heading will be achieved
- Alter course to port or starboard in multiples of 1° and 10°

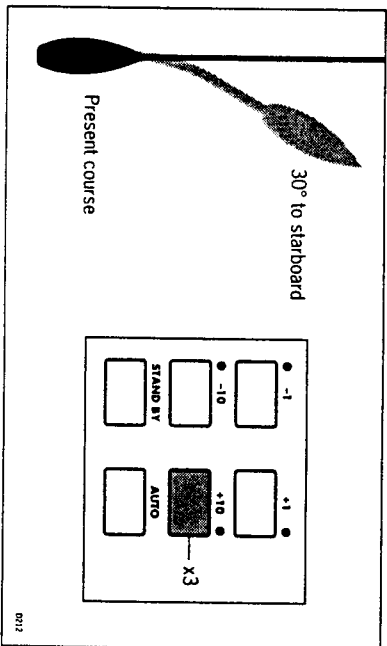

- Push **Standby** and lift the actuator from the tiller pin to return to hand steering

Operating sense reversal

The operating sense of the Autopilot can be reversed as follows:

- Press the **+1** and **-1** keys together for 5 seconds

The display will then show either port or starboard and the phase of the autopilot will automatically change.

The Control head will automatically revert back to its normal operation after 5 seconds.

Note: This should normally only be required if the actuator is port hand mounted.

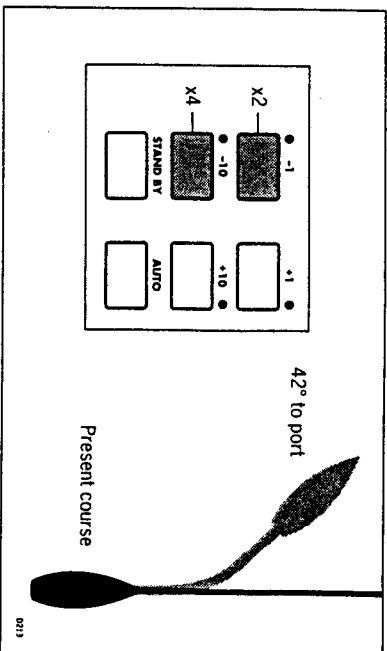

Chapter 8: Accessories

Various accessories are available for your ST4000 autopilot. These include:

- Handheld remote control (Z101)

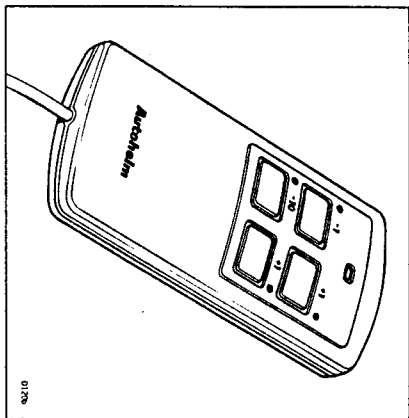

The handheld remote is supplied with 6m (20ft) of cable and a waterproof plug and socket. It allows you remote access to the four autopilot course change buttons.

- Fixed control units – ST7000 (Z082), ST6000 (Z124)

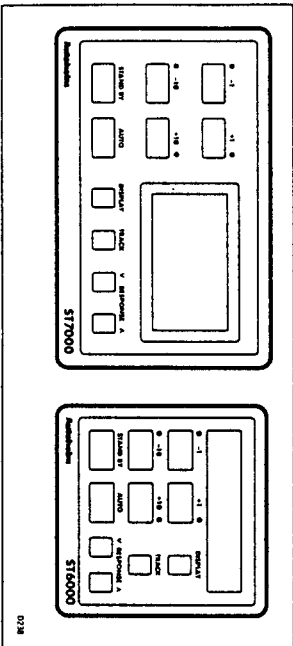

These control units are available for permanent mounting at additional positions where autopilot control is desired.

- Digital Windvane (Z087)

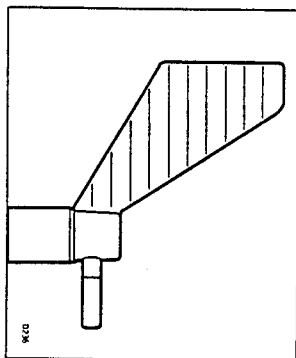

The digital windvane also requires the SeaTalk interface. When combine with the ST4000 these two pieces of equipment allow you to steer your boat on any course relative to an apparent wind angle.

- SeaTalk Interface (Z137)

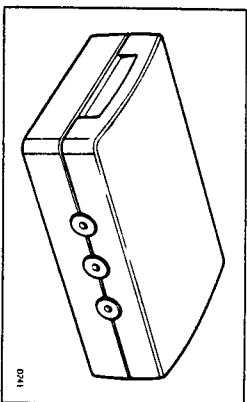

The SeaTalk Interface will convert all SeaTalk data to NMEA 0183. This allows you to feed NMEA 0183 Navigation data to a plotter or Speed and Compass NMEA information back to a position transducer for dead reckoning, (assuming the correct instruments are present on the SeaTalk bus to generate the information initially).

- Rudder Reference Transducer (Z131)

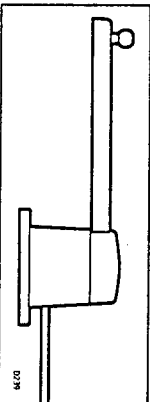

A rudder reference transducer can be added to provide a continuous read out of rudder position.

Chapter 9: Maintenance

Control head

- In certain conditions, condensation may appear on the window. This will not harm the unit, and can be cleared by switching on the illumination
- Never use any chemical or abrasive materials to clean your ST4000. If the Control head becomes dirty wipe clean with a damp cloth

Drive unit

- Never use any chemical or abrasive materials to clean your drive unit. If the drive becomes dirty wipe clean with a damp cloth

Cabling

- Avoid running cables through bilges where possible and secure any coiled lengths at regular intervals
- Avoid running cables close to fluorescent lights, engines, radio transmitting equipment etc
- Check cabling for chafing or damage to outer casing, replace where necessary and re-secure

Advice

Should any difficulties arise, please consult Nautech's Product Support department in the U.K. or your own National Distributor who will be able to provide expert assistance.

The working parts of the drive system are sealed and lubricated for life during manufacture and therefore do not require servicing.

If a fault does develop the autopilot's plugability ensures that only the defective unit be returned.

Before this is done please double check that the power supply cable is sound and that all connections are tight and free from corrosion. Then refer to the fault finding section of this manual. If the fault cannot be traced then please contact your nearest Autohelm dealer or service center for advice.

Always quote the serial number, which is printed on the label on the back of the control head.

Chapter 10: Fault Finding

All Autohelm products are subject to a comprehensive test procedure prior to packing and shipment. In the unlikely event that a fault does arise the following check list should help cure the problem.

Fault	Cause	Action
Control Head display blank	No supply	Check supply. Check Fuse/breaker. Return head for repair
Displayed heading does not change in Standby mode	Fluxgate compass mis-connected	Check compass connections on rear of Control head
Rudder position display cannot be called up	No Rudder reference transducer fitted Calibration level 8 (Steering type) set incorrectly	Fit Rudder reference transducer Set calibration level 8 to 3 (See chapter 4)
Drive unit steers helm hard over as soon as Auto is engaged	Drive phase set incorrectly	Refer to chapter 7 and carry out the functional test.
Displayed compass heading does not agree with Ships compass	Compass requires deviation correction and alignment	Refer to chapter 7 Automatic compass deviation correction
Vessel turns slowly and takes a long time to come onto course	Rudder gain too low	Refer to section 3.1 Setting up Rudder gain
Vessel overshoots when turning onto a new course	Rudder gain too high	Refer to section 3.1 Setting up Rudder gain
Displayed rudder angle not zero when helm is amidships	Rudder offset incorrectly set	Refer to chapter 4 Autopilot recalibration and set up level 2
Vessel remains off course when a course change is made	Automatic trim set up incorrectly	Refer to section 3.2 Setting up automatic trim
Pilot appears to be unstable on Northerly headings (Southernly in Southern hemisphere)	Northerly/Southerly heading correction not set-up	Refer to chapter 4 Autopilot re-calibration and set-up levels 10 and 11

Fault	Cause	Action
Drive actuator hurls when trying to position the rudder	Rudder damping incorrectly set	Refer to chapter 4 Autopilot re-calibration and set-up level 13
Display shows Cal - Off when entering calibration	Calibration locked out	Security protection switched on by owner
Control head will not talk to other Seatalk instruments or Control units	Cabling problem	Check security of all Seatalk connectors and cables
Control head will not receive information from a Position Transducer(GPS, Loran etc.)	Position Transducer not transmitting correct sentences	Refer to chapter 6 to verify connection. Refer to section 6.3 to confirm the correct sentences are being transmitted
Pilot will not auto-advance between waypoints	No Bearing to waypoint information transmitted from the position transducer	Refer to position transducer handbook
Pilot will not display Distance to waypoint, Bearing to waypoint or waypoint number	Incorrect NMEA sentences transmitted from Position transducer	Refer to section 6.3 for sentence requirement

Index

- A**
- Accessories 76
 - Additional Control units 76
 - Handheld control unit 76
 - Rudder Reference Transducer 77
 - Seatalk interface 77
 - Windvane 77
- Auto 8**
- Automatic Control Deadband (Auto seastate) 12
 - Autopilot re-calibration 31
 - Automatic Tack (Autotack) 13
 - Automatic Trim 30
- B**
- Basic principals (Operation) 7
- C**
- Calibration 31
 - Cruise Speed (Calibration Level 5) 35
 - Disabled access 41
 - Entering calibration 31
 - Exiting calibration 32
 - Factory settings 33
 - Current Vessel Latitude (Calibration Level 11) 38
 - Magnetic variation (Calibration Level 9) 37
 - Northerly/Southerly heading error correction (Calibration Level 10) 37
 - Off course alarm angle (Calibration Level 6) 35
 - Recording settings 40
 - Rudder damping (Calibration Level 13) 39
 - Rudder Gain (Calibration Level 1) 34
 - Rudder Offset (Calibration Level 2) 34
 - Rudder Limit (Calibration Level 3) 34
 - Steering system type (Calibration Level 8) 37
 - Suggested settings (Power/sail boats) 32
- Trim Level (Calibration Level 7) 36**
- Turn Rate Limit (Calibration Level 4) 35
 - Magnetic Variation (Calibration Level 9) 37
 - Compass alignment 73
 - Compass deviation correction 73
 - Control head 45
 - Sling 45
 - Mounting procedure 45
 - Power supply connection 47
 - Seatalk bus connection 48
 - Course changes 9
 - Cross track error 21
 - Cruise speed 35
- D**
- Dodge 10
- F**
- Fault Finding 79
 - Fluxgate Compass 49
 - Alignment 73
 - Cabling 51
 - Deviation correction 73
 - Installation 49
 - Mounting position 49
 - Functional test 69
 - Operating sense 69
 - Rudder reference phase 70
 - Navigation interface 70
 - Wind transducer interface 71
 - Seatalk bus 72
 - Fuse ratings 47
- H**
- Handheld remote control unit 76
- I**
- Illumination 14

M

Magnetic variation 37
Maintenance 78

.N

Navigation Interface 67
NMEA
Data Format/headers 68
Transmission to other equipment 67
Northerly heading error 37

O

Off Course Alarm 14
Operating sense 69

P

Power supply 47

R

Rudder Angle display 70
Rudder Gain 28
Rudder Reference 51
Accessory 77
Cabling 53
Control dimensions 52
Installation 51
Mounting position 51
Phase 70

S

Safety 4
SeaTalk
Operation with other SeaTalk
Instruments 3, 49, 72
Connection to bus 48
Functional test 69
Sea trial 69
Standby 8
Steering system type 37
Southerly turning error 37

T

Tacking (Autotack) 13
Track Control 11, 20
Automatic acquisition 20
Cross track error 21
Data error warning 25
Large cross track error warning 25
Manual acquisition 20
No data warning 25
Operation at Low speed 23
Operating hints 26
Operating limitations 23
Waypoint Advance 22
Warning messages 25
Trim (Auto trim) 30
Turn rate limit 35

W

Warning messages 25
Waypoint advance 25
Windvane (WindTrim) 11, 26
Accessory 77
NMEA input 67
Wind shift alarm 27